



# DEVILBISS® 5-LITER OXYGEN CONCENTRATOR SERVICE MANUAL



**DANGER – NO SMOKING**



MODEL 525DS  
MODEL 525DS-Q  
MODEL 525KS  
MODEL 525KS-LT  
MODEL 525PS



**CAUTION**

Federal (U.S.A.) law restricts this device to sale by or on the order of a physician.

# TABLE OF CONTENTS

## GENERAL INFORMATION

Introduction.....	3
Symbol Definitions.....	3
Important Safeguards.....	4

## UNPACKING AND SETUP

Initial Inspection.....	6
Patient Setup.....	6
Operating Instructions.....	6

## MAINTENANCE

Patient Alert System.....	8
Alarm Function Testing.....	8
Service Life.....	9
Routine Patient Maintenance.....	9
Periodic Homecare Provider Preventative Maintenance.....	10
Provider's Notes.....	10
Return and Disposal.....	11
Preventative Maintenance Summary.....	11

## TROUBLESHOOTING

System Operation.....	11
Normal Operating Sequence.....	12
Low Pressure System.....	12
Simplified Troubleshooting.....	13
Troubleshooting Chart A.....	14
Troubleshooting Chart B.....	15
Troubleshooting Chart C.....	15
Troubleshooting Chart D.....	15
Troubleshooting Chart E.....	16
Troubleshooting Chart F.....	16

## COMPONENT TESTING, REPAIR, AND REPLACEMENT

Proper Repair Procedures.....	17
Cabinet Removal.....	17
Accumulator Pressure Test.....	18
Auxiliary Oxygen Port.....	19
Capacitor.....	19
Check Valves/Manifold.....	19
Compressor.....	20
Cooling Fan.....	21
Flow Meter.....	22
Hour Meter.....	23
Manifold.....	23
Molecular Sieve Beds.....	23
Power Cord.....	24
Power Switch.....	24
Pressure Regulator.....	24
Printed Circuit Board (PC Board).....	25
Rotary Valve.....	25

## FIGURES, DIAGRAMS AND PARTS LIST

525DS Unit - Serial #F & 525DS / 525DS-Q Units - Serial #J (115V Units).....	27
525DS Unit - Serial #N & 525DS-Q Unit - Serial #R (115V Units with Auxiliary Oxygen Port).....	29
525DS Unit - Serial #B & 525DS-Q Unit - Serial #B (115V Units with Auxiliary Oxygen Port).....	32
525KS Unit - Serial #F & 525KS / 525KS-LT Units - Serial #J (220/230/240V Units).....	35
525KS-LT Unit - Serial #N & 525KS Unit - Serial #R (220/230/240V Units with Auxiliary Oxygen Port).....	37
525KS-LT Unit - Serial #B & 525KS Unit - Serial #B (220/230/240V Units with Auxiliary Oxygen Port).....	40
525PS Unit - Serial #F & 525PS Unit - Serial #J (220/230/240V Units).....	43
525PS Unit - Serial #B (220/230/240V Units with Auxiliary Oxygen Port).....	45
Accessories and Tools.....	47
Pneumatic and Wiring Diagrams.....	48

## ORDERING INFORMATION AND PARTS RETURN

Ordering Information.....	50
Parts Return.....	50

<b>WARRANTY</b> .....	51
-----------------------	----

<b>SPECIFICATIONS</b> .....	52
-----------------------------	----

<b>ELECTROMAGNETIC COMPATIBILITY INFORMATION</b> .....	54
--	----

# GENERAL INFORMATION

## INTRODUCTION

This service manual was designed to provide DeVilbiss Healthcare qualified service technicians and homecare providers with the proper maintenance, service, safety, and repair procedures for the DeVilbiss Oxygen Concentrator.

Read and understand all the information contained in this service manual before attempting to operate or perform any maintenance on the concentrator.





























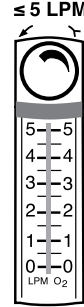



An oxygen concentrator is a device that delivers highly concentrated oxygen for therapeutic applications.

Room air is a mixture of 78% nitrogen, 21% oxygen, 1% argon and other gases. The concentrator draws in room air, separates the nitrogen from the oxygen, and delivers concentrated oxygen to the patient through an oxygen port.

For more in-depth classroom type training, contact the Respiratory Technical Service Department at 1-800-338-1988 (814-443-4881).

**NOTE**– DeVilbiss reserves the right to alter or change the design of the DeVilbiss Oxygen Concentrator series. Hence, slight differences in construction or components may exist between the unit in hand and what is described in this manual.

## SYMBOL DEFINITIONS

	It is mandatory to read and understand the operating instructions prior to use. <b>i</b> This symbol has a blue background on the product label.		Off On		LOT Number		Manufacturer
	Electric Shock Hazard. Cabinet to be removed by authorized personnel only. <b>i</b> This symbol has a yellow background on the product label.		Reset		Catalog Number		European Representative
	Danger - No smoking near patient or device. <b>i</b> This symbol has a red circle and diagonal bar on the product label.		Alternating Current		Serial Number		European Rep CE mark
	Use no Oil, Grease or Lubricants <b>i</b> This symbol has a red circle and diagonal bar on the product label.		Type B applied part		Normal Oxygen		Keep unit dry.
	Do not use near heat or open flames <b>i</b> This symbol has a red circle and diagonal bar on the product label.		Double Insulated		Low Oxygen		Maximum recommended flow rate: 5LPM
	General Warning <b>i</b> This symbol is used throughout this manual to indicate hazardous situations to avoid.		Hour Meter		Service Required		
	Important Information <b>i</b> This symbol is used throughout this manual to indicate important information you should know.		Operating Temperature Range +5 to +35°C (+41 to +95°F)		TUV Rheinland C-US approval mark		
	Note and Information Symbol <b>i</b> This symbol is used throughout this manual to indicate notes, useful tips, recommendations and information.		Atmospheric Pressure Range 840 to 1010 hPa (Approximate sea level to 5000 ft)		TUV Rheinland Certified approval mark		Inmetro approval mark
	Federal (U.S.A.) law restricts this device to sale by or on the order of a physician.				IP21		Ingress Protection - Protected against finger access to hazardous parts; protected against vertically falling water drops.
	This device contains electrical and/or electronic equipment that must be recycled per EU Directive 2012/19/EU- Waste Electrical and Electronic Equipment (WEEE)						

## IMPORTANT SAFEGUARDS

Read this entire guide before using your DeVilbiss concentrator. Important safeguards are indicated throughout this guide. Pay special attention to all safety information. Imminently and potentially hazardous information is highlighted by these terms:



### DANGER

Indicates an imminently hazardous situation which could result in death or serious injury to the user or operator if not avoided.



### WARNING

Indicates a potentially hazardous situation which could result in death or serious injury to the user or operator if not avoided.



### CAUTION

Indicates a potentially hazardous situation which could result in property damage, injury, or device damage if not avoided.



### IMPORTANT

Indicates important information you should know.



### NOTE

Indicates notes, useful tips, recommendations, and information.



### DANGER

- Oxygen causes rapid burning. Do not smoke while your oxygen concentrator is operating, or when you are near a person utilizing oxygen therapy.
- Smoking during oxygen therapy is dangerous and is likely to result in facial burns or death. Do not allow smoking within the same room where the oxygen concentrator or any oxygen carrying accessories are located.
  - If you intend to smoke, you must always turn the oxygen concentrator off, remove the cannula and leave the room where either the cannula or mask or the oxygen concentrator is located. If unable to leave the room, you must wait 10 minutes after you have turned off the oxygen concentrator before smoking.
- Oxygen makes it easier for a fire to start and spread. Do not leave the nasal cannula or mask on bed coverings or chair cushions if the oxygen concentrator is turned on but not in use. The oxygen will make the materials flammable. Turn the oxygen concentrator off when not in use to prevent oxygen enrichment.
- Keep the oxygen concentrator and cannula at least 2 m (6.5 feet) from hot, sparking objects or naked sources of flame.
- Open flames during oxygen therapy are dangerous and are likely to result in fire or death. Do not allow open flames within 2 m (6.5 feet) of the oxygen concentrator or any oxygen carrying accessories.
- DeVilbiss oxygen concentrators are equipped with a fire mitigating outlet fitting that prevents propagation of fire into the unit.



### WARNING

- To avoid electric shock, do not plug the concentrator into an AC outlet if the concentrator cabinet is broken. Do not remove the concentrator cabinet. The cabinet should only be removed by a qualified DeVilbiss technician. Do not apply liquid directly to the cabinet or utilize any petroleum-based solvents or cleaning agents.
- Improper use of the power cord and plugs can cause a burn, fire or other electric shock hazards. Do not use the unit if the power cord is damaged.
- Ensure the mains power cord is fully inserted into the concentrator connector (230 volt units) and the power cord plug is completely inserted into a fully functioning AC wall outlet. Failure to do so may cause an electrical safety hazard.
- See instructions for use regarding fire propagation prevention.
- Locate oxygen tubing and power supply cords to prevent tripping hazards and reduce the possibility of entanglement or strangulation.
- Do not lubricate fittings, connections, tubing or other accessories of the oxygen concentrator to avoid the risk of fire and burns.
- Do NOT use lubricants, oils or grease.
- Before attempting any cleaning procedures, turn the unit "Off."
- Use only water-based lotions or salves that are oxygen-compatible before and during oxygen therapy. Never use petroleum or oil-based lotions or salves to avoid the risk of fire and burns.
- Use only spare parts recommended by the manufacturer to ensure proper function and to avoid the risk of fire and burns.
- When using the Transfiller Caddy with a Transfill device, always keep the system on a flat surface. Disassemble the system prior to moving.

# GENERAL INFORMATION



## WARNING

- If you feel discomfort or are experiencing a medical emergency while undergoing oxygen therapy, seek medical assistance immediately to avoid harm.
- Geriatric, pediatric or any other patient unable to communicate discomfort can require additional monitoring and/or a distributed alarm system to convey the information about the discomfort and/or the medical urgency to the responsible caregiver to avoid harm.
- Use of this device at an altitude above 13,123 feet (4000 meters) or above a temperature of 95°F (35°C) or greater than 93% relative humidity may affect the flow rate and the percentage of oxygen and consequently the quality of the therapy. Refer to specifications for details regarding parameters tested.
- To ensure you receive the therapeutic amount of oxygen delivery according to your medical condition, the Oxygen Concentrator must:
  - be used only after one or more settings have been individually determined or prescribed for you at your specific activity levels.
  - be used with the specific combination of parts and accessories that are in line with the specification of the concentrator manufacturer and that were used while your settings were determined.
- Your delivery settings of the oxygen concentrator should be periodically reassessed for the effectiveness of therapy.
- For your safety, the oxygen concentrator must be used according to the prescription determined by your physician.
- Under certain circumstances, oxygen therapy can be hazardous. Seek medical advice before using an oxygen concentrator.



## WARNING

- Medical Electrical Equipment needs special precautions regarding EMC and needs to be installed and put into service according to the Electromagnetic Compatibility [EMC] information provided in the accompanying documents.
- Portable and Mobile RF Communications Equipment can affect Medical Electrical Equipment.

### MR Unsafe

- Do not bring the device or accessories into a Magnetic Resonance (MR) environment as it may cause unacceptable risk to the patient or damage to the oxygen concentrator or MR medical devices. The device and accessories have not been evaluated for safety in an MR environment.
- Do not use the device or accessories in an environment with electromagnetic equipment such as CT scanners, Diathermy, RFID and electromagnetic security systems (metal detectors) as it may cause unacceptable risk to the patient or damage to the oxygen concentrator. Some electromagnetic sources may not be apparent, if you notice any unexplained changes in the performance of this device, if it is making unusual or harsh sounds, disconnect the power cord and discontinue use. Contact your home care provider.
- This device is suitable for use in home and healthcare environments except for near active HF SURGICAL EQUIPMENT and the RF shielded room of an ME SYSTEM for magnetic resonance imaging, where the intensity of Electromagnetic DISTURBANCES is high.
- Use of this equipment adjacent to or stacked with other equipment should be avoided because it could result in improper operation. If such use is necessary, this equipment and the other equipment should be observed to verify that they are operating normally.
- Portable RF communications equipment (including peripherals such as antenna cables and external antennas) should be used no closer than 30 cm (12 inches) to any part of the oxygen concentrator, including cables specified by the manufacturer. Otherwise, degradation of the performance of this equipment could result.



## CAUTION

- It is very important to follow your oxygen prescription. Do not increase or decrease the flow of oxygen – consult your physician.
- The surface temperature of the exhaust vents on the bottom of the unit may exceed 105.8°F (41°C) under certain conditions.
- When device is used under extreme operating conditions, the temperature near the exhaust vents on the bottom of the unit may reach 145°F (63°C). Keep body parts a minimum of 32" (81.2 cm) away from this area.
- Use of harsh chemicals (including alcohol) is not recommended. If bactericidal cleaning is required, a non-alcohol based product should be used to avoid inadvertent damage.



## IMPORTANT

- It is recommended that the homecare provider lock the flow control knob to prevent inadvertent adjustment. A flow setting other than prescribed may affect the patient therapy.
- Do not service or clean this device while in use with a Patient.
- Installation of 515LF-607 low output flow meter package will cause the low flow alarm to not work and will prevent the device from meeting the requirements of ISO-80601-2-69:2014 Section 201.13.2.101.
- The Device is classified as IP21 which means it is protected against finger access to hazardous parts and protected against vertically falling water drops.
- Equipment not suitable for use in the presence of a flammable anesthetic mixture with air or with oxygen or nitrous oxide.
- This device contains electrical and/or electronic equipment. Follow local governing ordinances and recycling plans regarding disposal of device components.

# UNPACKING AND SETUP

## INITIAL INSPECTION

It is suggested that an initial inspection be performed upon receiving the oxygen concentrator.

1. After removing the DeVilbiss Oxygen Concentrator from the carton, examine it for any external damage. If shipping damage has occurred, contact the DeVilbiss Customer Service Department at 1-800-338-1988 (814-443-4881) for specific instructions. Save the carton for possible later return; note the position of the unit and placement of the packing material.
2. Check to be sure the intake bacteria filter is in place.
3. Plug the unit into an electrical outlet, turn the unit "On," and check the audible and visible alerts.
4. Set the flow meter to maximum recommended liter flow and let the unit run for at least 20 minutes. Also record the number of hours on the hour meter.
5. Use an oxygen analyzer to check the concentration.
6. With unit still running, unplug to test the power fail alarm.

**NOTE**– If the unit fails to operate properly (oxygen concentration not within specification) or if internal damage is found, contact the DeVilbiss Customer Service Department at 1-800-338-1988 (814-443-4881).

## PATIENT SETUP

1. Position the unit near an electrical outlet in the room where the patient spends most of his or her time.

**NOTE**– Do not connect to an electrical outlet controlled by a wall switch.

2. Position the unit at least 6 inches (16 cm) from walls, draperies, or any other objects that might prevent the proper flow of air in and out of the oxygen concentrator.
3. Locate the unit a minimum of 6.5 feet (2 m) from fireplaces, radiators, heaters, and hot-air registers.



### WARNING

Oxygen causes rapid burning. Do not smoke while your oxygen concentrator is operating, or when you are near a person utilizing oxygen therapy. Keep the oxygen concentrator and cannula at least 6.5 feet (2 m) from hot, sparking objects or naked sources of flame.

Electric Shock Hazard. Only qualified DeVilbiss Healthcare homecare providers may remove the cabinet.

4. Attach the appropriate oxygen accessories (oxygen tubing or humidifier) to the oxygen outlet port.

**NOTE**– The bubble humidifier should be supplied with a permanent fire stop device. If a bubble humidifier needs to be used without a permanent fire stop device, a secondary fire stop device must be used and placed as close to the humidifier as possible. Failing to do so could increase the risk of fire.

**NOTE**– A maximum of 50 feet (15 meters) of tubing plus 7 feet (2.1 meters) of cannula plus a bubble humidifier is allowed between the concentrator and the patient.

**NOTE**– The oxygen supply accessory (patient tubing) shall be equipped with a means that in case of fire stops the delivery of oxygen to the patient. This means of protection should be located as close to the patient as practicable.

## Oxygen Tubing Only Connection

1. Thread the cannula fitting onto the oxygen outlet port.
2. Attach the 5/32" (4 mm) I.D. oxygen tubing.

## Oxygen Tubing with Humidification Connection

If the physician has prescribed an oxygen humidifier as part of the patient's therapy, follow these steps (If using a prefill, go to Step 3.):

1. Fill the humidifier bottle with distilled, demineralized, or boiled water. Do not overfill.
2. Thread the wing nut located on the top of the humidifier bottle to the oxygen outlet port so that it is suspended. Make sure it is securely tightened.
3. Attach the 5/32" (4 mm) I.D. oxygen tubing, not to exceed 50 feet (15 meters), directly to the humidifier bottle outlet fitting.

**NOTE**– For optimum performance, the DeVilbiss Oxygen Concentrator has a preset nominal output pressure of 8.5 psi (58.6 kPa). Use only "bubble-type" humidifiers. Do not use "jet-type" humidifiers.

**NOTE**– Condensation from the humidifier may occur in longer lengths of tubing or if the tubing is laying on a cold floor.

## When ready for operation

1. Attach the nasal cannula to the oxygen tubing (per the manufacturer's directions).
2. Follow the Operating Instructions.

## OPERATING INSTRUCTIONS

1. Remove the power cord completely from the strap. Make sure the power switch is in the "Off" position.
2. **115 Volt Units**– Insert the plug into an electrical outlet. The DeVilbiss Oxygen Concentrator uses a two-prong polarized plug and is double-insulated to protect against electric shock.  
**220/230/240 Volt Units** – Ensure cord is connected to the unit before inserting plug into an appropriate electrical outlet.



### WARNING

The plug on the DeVilbiss 525DS concentrators has one blade wider than the other. To reduce the risk of electric shock, this plug is intended to fit in a wall outlet only one way. Do not attempt to defeat this safety feature.

Improper use of the power cord and plugs can cause a burn, fire, or other electric shock hazards. Do not use the unit if the power cord is damaged.

Oxygen causes rapid burning. Do not smoke while your oxygen concentrator is operating, or when you are near a person utilizing oxygen therapy. Keep the oxygen concentrator and cannula at least 6.5 feet (2 m) from hot, sparking objects or naked sources of flame.

3. Press the power switch to the "On" position. When the unit is turned "On," all three lights (Service Required, Low Oxygen, and Normal Oxygen) on the front panel will briefly illuminate and an audible signal will sound momentarily. The unit will then operate in "start up" mode with the Low Oxygen light lit until a normal oxygen level is achieved at which time the Normal Oxygen light will remain lit. The "start up" may take up to 15 minutes.

**NOTE**– DeVilbiss recommends for optimal service life that the DeVilbiss Oxygen Concentrator to be operated for at least 30 minutes after it is powered on. Shorter periods of operation, operating in extreme

## UNPACKING AND SETUP

*temperature/humidity conditions or in the presence of contaminants, and/or handling and storage conditions outside those specified, may affect the long term reliable operation of the product.*

4. Slowly turn the flow meter knob until the flow meter ball is centered on the line next to the appropriate flow rate.

**NOTE**– *When the flow meter knob is turned clockwise, the flow decreases (and eventually will shut off the oxygen flow). When the knob is turned counter-clockwise, the flow increases.*

**NOTE**– *For prescriptions of 5 LPM, be sure the ball is centered on the 5 liter line; the ball should not touch the red line. Setting the flow higher than 5 may cause the oxygen purity level to drop.*

**NOTE**– *Use low output flow meter (part #515LF-607) for flow rates under 1 lpm.*

**NOTE**– *Installation of 515LF-607 low output flow meter package will cause the low flow alarm to not work and will prevent the device from meeting the requirements of ISO-80601-2-69:2014 Section 201.13.2.101.*

**NOTE**– *The low-flow alarm may activate if the flow meter ball is set at or below .5 lpm. The unit will continue to run; however, the Service Required light will come on accompanied by an audible alarm. Adjust the flow meter to your prescribed flow.*

**NOTE**– *The unit may require up to 20 minutes for the oxygen concentration and flow rate to stabilize. The flow rate should be monitored and readjusted if necessary.*

5. The flow meter has a locking device. If it is necessary to preset and lock in the prescribed flow rate, tighten the set screw located on the hex nut just below the control knob using a 1/16" Allen bit. No adjustment can be made without loosening the set screw.
6. The DeVilbiss oxygen concentrator is now ready for use.

## PATIENT ALERT SYSTEM

The DeVilbiss Oxygen Concentrator patient alert system will detect unit component failure. This system is comprised of both visible and audible alerts which signal the patient if a malfunction should occur.

### DeVilbiss OSD® Operation

The OSD is a device within DeVilbiss concentrators that monitors the oxygen produced by the unit. The OSD operates as follows:

- Normal Oxygen (green light) - oxygen purity normal
- Low Oxygen (yellow light) - oxygen purity low—requires servicing

If the oxygen purity continues to fall, an audible signal will sound intermittently. If the oxygen purity continues to fall to a low enough level, the yellow “Low Oxygen” light will turn off and the red “Service” light will turn on.

**NOTE**– Refer to the Alerts section below for specific alert settings.

After Power On, the OSD conducts a continuous diagnostic evaluation to check for a fault in the piezo electronics. If this condition is detected by the OSD electronics at any time during concentrator operation, the green “Normal Oxygen” OSD light will turn off and the beeping audible alert and blinking red “Service” light will activate. Otherwise for the first fifteen minutes of operation, the green “Normal Oxygen” light will remain illuminated during the oxygen stabilization process. After that time, the OSD will begin monitoring the oxygen purity every second.





### For units with Serial Numbers starting with B

After power on, the electronics continuously monitor the oxygen sensor. If a fault is detected, the green "Normal Oxygen" light will turn off and the beeping audible alert and blinking red "Service Required" light will activate.

During the first 15 minutes, the unit will be in “Start Up” mode. The oxygen purity is continuously monitored and the green “Normal Oxygen” light will turn on as soon as the therapeutic oxygen levels are obtained. After 15 minutes stabilization time, if the O<sub>2</sub> is less than 85% the yellow Low O<sub>2</sub> LED will be on and a beeping audible alarm will occur. If the level is below 60% (after startup) then the yellow and red LEDs will be lit along with a beeping audible alarm. The audible low O<sub>2</sub> alarms are blocked during the 15 minute stabilization delay, and also during the 10 minute stabilization delay that occurs during turn-down mode enter/exit.

### Alerts:

There are two visible service alerts located on the front panel.

For serial numbers starting with B, J, N or R		For serial numbers starting with F	
 ↓ O <sub>2</sub> Low O <sub>2</sub> %	 Service	 Low O <sub>2</sub> %	 Service

The audible alert system is internally powered; no batteries are required. If the indicator lights illuminate or the audible alert sounds other than during start-up, a problem has occurred

- Power Failure (Blinking red “Service” light and pulsing audible alert)
- Low Flow (Below 0.5 lpm) (Continuous red “Service” light and audible alert)
- Below Normal Oxygen (84% to 75%, yellow “Low Oxygen” light. 75% to 60%, yellow “Low Oxygen” light and beeping audible alert. Less than 60%, red “Service” light and beeping audible alert.)

The visible and audible alerts will activate for approximately 15 minutes in a no power situation. If the unit is turned “On” without power or power is removed later, no alert will sound for the first 10 seconds. After that time, the alert will

produce an audible pulse every few seconds while the visible alert blinks. Power for this alert is provided by a capacitor on the PC board.

### For units with Serial Numbers starting with B

The audible alert system is internally powered; no batteries are required. If the indicator lights illuminate or the audible alert sounds other than during start-up, a problem has occurred

- Power Failure (Pulsing audible alert)
- Low Flow (Below .5 lpm) (Continuous red “Service” light and audible alert)

#### Below normal O<sub>2</sub>:

- The yellow Low Oxygen light will illuminate with an audible alarm at <85%.
- The yellow Low Oxygen and red Service Required lights will illuminate with an audible alarm at <60%.

The audible alert will activate for a minimum of two minutes in a no power situation. There is no visual indicator for this alarm. If the unit is turned “On” without power or power is removed later, the alert will sound within 10 seconds. After that time, the alert will produce an audible pulse every few seconds. Power for this alert is provided by a capacitor on the PC board.

**NOTE**– If the concentrator has been unused for an extended period, the unit must run several minutes before the power fail alert will activate.

The PC (printed circuit) board is responsible for controlling the system and alerts.

**NOTE**– A high pressure condition is indicated by the audible (a “popping” sound) release of pressure from a pressure relief valve located on the compressor head.

**NOTE**– Installation of 515LF-607 low output flow meter package will cause the low flow alarm not to work and will prevent the device from meeting the requirements of ISO-80601-2-69:2014 Section 201.13.2.101.

## ALARM FUNCTION TESTING

The 525 series is designed to activate alarms when certain conditions or failures occur. The alarm functions may be tested following the procedures below:

- Overheating:
  - Remove the front and rear covers from the concentrator; then disconnect the cooling fan from the printed circuit board.
  - Replace the front and rear covers.
  - Place the concentrator in a location that has an ambient temperature of approximately 70° F. Then plug the unit into the appropriate mains voltage and turn it on.
  - Allow the unit to operate until the Service Required Alarm activates, which should be within approximately two hours.
- Compressor Failure:
  - Remove the rear cover from the concentrator; then disconnect the compressor electrical connector from the main wire harness.
  - Plug the unit into the appropriate Mains voltage and turn it on.
  - Allow the unit to operate until the Service Required Alarm activates, which should be within approximately two minutes.
- Low Flow / Obstruction of Gas Pathway:
  - Plug the concentrator into the appropriate mains voltage and turn it on.
  - Allow the device to run for several minutes.
  - Turn the flow meter off so that there is no oxygen flowing out of the unit.
  - Allow the unit to operate until the alarm condition occurs (red light and audible beep).

- e. Increase the flow to 1 LPM and confirm that the alarm condition ends.
4. High Flow
  - a. Connect the oxygen concentrator to AC power and turn the power switch on.
  - b. Allow the device to run for several minutes.
  - c. Adjust the output flow to more than 6.0 LPM using the flow meter knob (turn counter clockwise until ball goes above 6.0 LPM).
  - d. The alarm condition (yellow light) should occur.
  - e. Decrease the flow to 5 LPM and confirm that the alarm condition ends.
5. Oxygen Generation Mains Failure:
  - a. Plug the concentrator into the appropriate mains voltage and turn it on.
  - b. Turn the flow meter to 5 LPM.
  - c. Attach another flow meter to the auxiliary oxygen port which is located on the rear of the concentrator and then adjust the flow to 3 LPM.
  - d. Allow the unit to operate until the Service Required Alarm is activated, which should be within approximately thirty minutes.
6. Pressure Failure:
  - a. Remove the front and rear covers from the concentrator.
  - b. Disconnect the tubing from the top of one of the sieve beds.
  - c. Plug the unit into the appropriate mains voltage and turn it on.
  - d. Turn the flow meter to 5 LPM.
  - e. Allow the unit to operate until the Service Required Alarm is activated, which should be within approximately thirty minutes.
7. Power Supply Failure
  - a. Connect the oxygen concentrator to AC power and turn the power switch on. Allow the device to run for several minutes.
  - b. With the power switch in the on position, unplug the AC power cord from the outlet.
  - c. The alarm condition (audible beep) should occur and continue for a minimum of 120 seconds. There is no visual indicator for this alarm condition.
  - d. Reconnect the AC power cord and confirm that the alarm condition ends.
8. Malfunction – O2S Gas Temperature High
  - a. This alarm condition is tested automatically during start-up.
9. Malfunction – Corrupted Settings
  - a. This alarm condition is tested automatically during start-up.
10. Malfunction – Non-Recoverable Valve Error
  - a. This alarm condition is tested automatically during start-up.
11. Malfunction – O2S Oxygen Sensor Communication Failure
  - a. This alarm condition is tested automatically during start-up.
12. Low Oxygen Concentration – Startup Period
  - a. Connect the oxygen concentrator to AC power and turn the power switch off.
  - b. Leave the device off for several minutes until the outlet flow is zero (flow meter ball at zero).
  - c. Turn the power switch to the on position. The alarm condition (yellow light) occurs during startup until the oxygen concentration reaches 85%.
13. Low Oxygen Concentration – Startup Period Over
  - a. This alarm condition is tested automatically during start-up. Once the oxygen concentration reaches 85% the green light comes on.

## Service Life

The expected service life of the 525 is 5 years of operation, when used in accordance with all manufacturer guidance for safe use, maintenance, storage, handling and general operation. Expected service life of the unit, and in particular the sieve beds and compressor, may vary based on the operating environment, storage, handling and the frequency and intensity of use.

## ROUTINE PATIENT MAINTENANCE

DeVilbiss recommends using only original DeVilbiss parts and filters in order to guarantee a reliable operation of the product.

The oxygen patient should perform the following maintenance:

### Cannula, Tubing, and Humidifier Bottle

The patient should clean and replace the cannula, tubing, and humidifier bottle according to the manufacturer's instructions.

### Air Filter

**NOTE**– Recent updates made to the oxygen-generating / flow systems within the concentrator have eliminated the need for the gross particle filter to be included on future production units. The filter door has been reconfigured to allow for increased air flow through horizontal slots without the filtration material included.

The redesigned filter door is standard on all 525 models as of October, 2020. Although the filter is no longer required when using the new filter door, a recess inside the door has been created, should a provider still desire to have a gross particle filter included.

The new filter door is backwards compatible with older 525 models.

The maintenance guidelines below should still be followed for those concentrators that have the gross particle filter.

The air filter should be inspected periodically and cleaned as needed by the user or caregiver. Replace if torn or damaged. To clean, follow these steps:

**NOTE**– Frequency of inspection and cleaning of filter may be dependent upon environmental conditions like dust and lint.

1. Remove the air filter located in the door on the back of the unit.
2. Wash in a solution of warm water and dishwashing detergent.
3. Rinse thoroughly with warm tap water and towel dry. The filter should be completely dry before reinstalling.



### WARNING

Do not attempt to operate the unit without the air filter or while the filter is still damp.

**NOTE**– The air filter should be monitored more closely in environments with abnormal amounts of dust and lint.



### CAUTION

Operation of the DeVilbiss Oxygen Concentrator in extreme environments or without the air filter will prematurely occlude the intake bacteria filter and cause a decrease in the unit performance.

### Exterior Cabinet

The patient should clean the concentrator exterior cabinet weekly by using a damp cloth or sponge with a mild household cleaner and wiping it dry.



### WARNING

Do not apply liquids directly to the cabinet or utilize any petroleum-based solvents or cleaning agents.

## PERIODIC HOMECARE PROVIDER PREVENTATIVE MAINTENANCE

Use only DeVilbiss concentrator replacement parts and accessories.

Every DeVilbiss Oxygen Concentrator is tested at the factory. To assure continued trouble-free performance, the following preventative maintenance should be performed by the homecare provider during periodic oxygen patient visits not to exceed 3 years. Failure to properly maintain the unit will void the warranty.

1. Check the oxygen concentration with an oxygen analyzer (part #R217P62) every 3 years.
  - a. Calibrate the oxygen analyzer prior to checking the oxygen concentration. The analyzer should be properly calibrated using the manufacturer's recommended procedure.
 

**NOTE**– Changes in temperature, altitude, or humidity may affect the analyzer's oxygen concentration reading. The analyzer should be calibrated in similar conditions to the location of the concentrator.
  - b. Power the unit, set the flow meter to 5 LPM and connect the analyzer to the unit's oxygen outlet port.
  - c. Wait 20 minutes for the display to stabilize. The concentrator must operate for a minimum of 20 minutes before checking the oxygen concentration.
  - d. Record the reading.
2. Check the audible alert and indicator lights during every service. When the power switch is turned "On," listen for the audible alert and check to see if the front panel indicator lights are operating.
3. Inspect cabinet air filter (part #303DZ-605) every PM check. Replace if filter is torn or damaged. Units manufactured since October, 2020 do not have a gross particle or cabinet air filter. See note under Air Filter on page 9.
4. Inspect intake bacteria filter (part #MC44D-605) during every PM Check. Replace as necessary.
  - a. Open the filter door and replace filter as required.
5. Inspect the final bacteria filter (part #PV5LD-651) during every compressor service. Replace as necessary.
  - a. Use the Cabinet Removal instructions found under CABINET REMOVAL in this manual to remove and attach the cabinets.
  - b. Remove the hose from each end of the filter and discard the filter.
  - c. Install the new final bacteria filter with the "IN" fitting toward the flow meter.
6. Inspect the compressor filter during every compressor service. Replace as necessary.

**NOTE**– A change was made to the type of compressor filter used in the 525 series concentrator. The unit may have one of two different types of compressor filters depending on when the concentrator was manufactured. The original one is a white plastic filter that is located near the compressor. The newer style is a sintered bronze filter (525DD-626) that is installed in one end of the compressor exhaust hose near the rotary valve. All models of the 525 series are now being manufactured with the sintered bronze compressor filter. See figure below.



**Sintered Bronze Compressor Filter (525DD-626)**

**NOTE**– This PM Schedule reflects:

- 5000 hour usage equal to one year
- a normal, clean operating environment.

The homecare provider is responsible for:

- determining the condition of the concentrator operating environment.
- determining a preventative maintenance interval frequency\* which takes into consideration the specific operating environment.

\* Standard intervals are noted below. Service interval may be more or less frequent than stated below provided that the Home Care

Provider establishes and documents appropriate protocols.

7. Inspect AC power cord, power switch and circuit breaker every PM check or between patients. Replace as necessary.

## PROVIDER'S NOTES - Cleaning and Disinfection When There is a Patient Change

DeVilbiss Healthcare recommends that at least the following procedures be carried out by the manufacturer or a qualified third party between uses by different patients.

**NOTE** – If the following described complete processing of the concentrator by an appropriately trained individual is not possible, the device should not be used by another patient.

**NOTE** – If preventive maintenance is due at this time, these procedures should be carried out in addition to the servicing procedures.

1. Use disinfectants safely. Always read the label and product information before use.
2. Always wear personal protective equipment when performing this procedure. Use suitable gloves and safety glasses. Cover exposed skin on arms to prevent accidental contact with bleach solution that has been applied to the concentrator.
3. Dispose of all accessories that are not suitable for reuse. This includes but may not be limited to the oxygen tubing, tubing connectors, nasal cannula and/or mask, oxygen outlet connector, and humidifier bottle.
4. Clean the exterior of the concentrator with a clean lint-free cloth. Heavy soil should be removed with a clean lint-free cloth dampened with water. A soft bristled brush dampened with water can be used to remove stubborn soil. Dry the concentrator using a clean lint-free cloth if water was used to remove soil.
5. Use 5.25% chlorine bleach (Clorox Regular Liquid Bleach or equivalent). Mix one (1) part bleach with four (4) parts water in an appropriate clean container. This ratio produces a one (1) part bleach to five (5) total parts solution (1:5). The total volume (amount) of solution required is determined by the number of concentrators in need of disinfection. **NOTE**– An alternate suitable disinfecting agent (e.g. Mikrobac® forte or Terralin® Protect) may also be used. Follow disinfectant manufacturer's instructions.
6. Apply the bleach solution in an even manner to the cabinet and power cord using a clean lint-free cloth. The cloth should be dampened only and not dripping of solution. Do not use a spray bottle to apply the solution. Do not saturate the device with the solution. Take care that no solution enters the vent areas on the concentrator base or the Auxiliary O2 fitting area on the back of the unit. Avoid over-saturating the cabinet seams so that no solution residue builds up in these areas. Avoid the caster wells located on the bottom of the unit.
7. Exposure time of the disinfectant solution should be 10 minutes minimum to 15 minutes maximum.
8. After the recommended exposure time, all surfaces of the concentrator should be wiped with a clean lint-free cloth dampened with drinking quality water no warmer than room temperature. Dry the unit with a dry, clean lint-free cloth. This is to remove residue that may stain or leave a film on the unit, especially after repeated disinfections.
9. Check the cord, the plug on the back of the device, the power switch, the fuse holder, and the indicator lights for possible damage. Replace all damaged or worn components.
10. Replace the cabinet air filter on the back of the device.
11. Check the oxygen concentration. If the device is within specification, the extended life intake bacteria filter does not need to be replaced between patients. If the oxygen concentration is not within specification, the provider should refer to the service manual section on Troubleshooting.
12. **OPTIONAL INSIDE CLEANING:** The concentrator must be disconnected from the power supply for this step: Open the concentrator and remove all

dust deposits inside the cabinet with an appropriate vacuum cleaner. Close the concentrator.

**NOTE** – *There is no portion of the gas pathways through the concentrator that could be contaminated with body fluids under normal conditions.*

The device patient connection may unintentionally become contaminated with expired gases for a single fault condition i.e., a hose internal to the device becomes disconnected. This condition will cause no flow out of the device and/or an alarm condition. Should this occur, refer to the service manual section on Troubleshooting.

## Cleaning

	Recommended cleaning interval	Number of cleaning cycles *	Compatible cleaning method
Outer Cabinet	7 days	260	Water, use only a damp cloth
Air Filter Units manufactured since October, 2020 do not have a gross particle or cabinet air filter. See note under Air Filter on page 9.	7 days	104	Mild dish soap (2 tbsp) and warm water (2 cups)
Oxygen Outlet Connector	7 days	104	Mild dish soap (2 tbsp) and warm water (2 cups)
Filter Door Vents	7 days	260	Wipe with dry cloth, or a cloth dampened with water to remove dust

\* number of cleaning cycles determined by recommended cleaning interval and expected service life

## Disinfection

**NOTE**– *The disinfection process can only be completed by the manufacturer or by a qualified DeVilbiss provider/service technician.*

	Recommended disinfection interval	Number of disinfection cycles	Compatible disinfection method
Cabinet parts, power cord	Between patients	20	1:5 chlorine bleach (5.25%) and water solution, Mikrobac forte, Terralin Protect
Oxygen tubing, tubing connectors, nasal cannula/ mask, oxygen outlet connector, humidifier bottle, cabinet air filter	Do not clean, replace between patients	N/A	N/A
Optional - Inside cabinet	Between patients	N/A	Remove dust with a vacuum cleaner

## RETURN AND DISPOSAL

This device may not be disposed of with household waste. After use of the device, please return the device to the provider for disposal. This device contains electrical and/or electronic components that must be recycled per EU Directive 2012/19/EU-Waste Electrical and Electronic Equipment (WEEE). Non-infectious used accessories (e.g. nasal cannula) can be disposed of as residential waste. The disposal of infectious accessories (e.g. nasal cannula from an infected user) must be made via an approved waste disposal company. Names and addresses can be obtained from the local municipality.

## PREVENTATIVE MAINTENANCE SUMMARY

### Patient / Caregiver

Clean and replace oxygen tubing, cannula / mask, and humidifier bottle (if used) according to manufacturer's instructions.

### Homecare Provider

#### During each inspection

- Wash/Replace cabinet filter if applicable.
- Check audible alert and indicator lights.
- Clean filter door vents if applicable.

#### During each PM check – not to exceed 3 years for the 525 series

- Inspect/Replace intake bacteria filter as necessary.
- Check oxygen purity.

#### During compressor service

- Inspect/ Replace final bacteria filter.
- Inspect/ Replace the compressor filter

**NOTE**– *There is no portion of the gas pathways through the concentrator that could be contaminated with body fluids under normal conditions.*

The device patient connection may unintentionally become contaminated with expired gases if a hose internal to the device becomes disconnected. This condition will cause no flow out of the device and/or an alarm condition. Should this occur, remove the front cabinet in order to determine where the disconnection occurred.

Replace all components from the free end of the disconnect through the outlet port. Reference the pneumatic diagram and replacement part numbers/ instructions.

## SYSTEM OPERATION

The DeVilbiss Oxygen Concentrator uses a pressure swing adsorption system. The air is drawn into the unit through air filters and into a double-head compressor.

A pneumatic diagram of the system is shown on page 48.

The compressed air passes through a rotary valve, which is cycled at a pre-determined rate, and is directed into one of two sieve beds. The sieve beds contain molecular sieve material which is a synthetically-produced inorganic silicate. It is very porous and has the unique ability to selectively adsorb nitrogen from the air as it passes through the sieve bed.

As one bed is being pressurized, the other bed is quickly depressurized. This allows the nitrogen that was adsorbed during its pressurization cycle to be exhausted from the sieve material.

The nitrogen is released through exhaust ports located on the rotary valve assembly. The ports are connected to a single piece of hose running from the valve to the exhaust muffler.

Also during each bed pressurization, a small amount of oxygen flows through an orifice from the pressurized bed into the depressurizing bed. This helps purge the nitrogen from the depressurizing bed.

The beds will continue to be alternately pressurized and depressurized as the unit operates.

Oxygen leaving the sieve beds is directed through a check valve to the accumulator tank. A pressure regulator on the tank controls the oxygen pressure as it leaves the accumulator and enters the flow meter. The flow meter allows the oxygen flow to be controlled and adjusted to the level prescribed by the patient's physician. From the flow meter the oxygen passes through the final bacteria filter and finally the oxygen outlet port to the patient.

The DeVilbiss Oxygen Concentrator operates on a timed cycle (3.6 sec. @ 5LPM) that is controlled by the PC board. The PC board will send voltage to the valve causing it to shift and alternately pressurize the sieve beds.

The PC board also activates the electronic alert system. Low flow, system abnormality, and power failure are indicated by audible and visible alerts. A high pressure condition will be indicated with a “popping” type sound produced by release of pressure from a pressure relief valve on the compressor head.

The 525 operating system incorporates “turn-down” technology. The PC board constantly monitors the flow rate and will decrease the cycle time whenever the flow rate is less than 1.2 LPM. Therefore it “turns-down” the cycle based on lower oxygen demand. As a result, the unit runs cooler and less power is consumed.

## NORMAL OPERATING SEQUENCE

When the concentrator is turned “On,” the following cycling sequence can be observed by attaching a pressure gauge to the manifold or accumulator tank test point.

1. The rotary valve is quickly cycled several times to relieve residual bed pressure preventing a static condition in the compressor. This rapid cycling only happens on start-up and is clearly heard as pressure is being quickly exhausted several times. The pressure exhausts through an exhaust muffler that is connected to the valve.
2. The PC board applies a short DC voltage signal to the valve. The valve will stop for several seconds causing the right bed to pressurize first while the left bed depressurizes.
3. Voltage is again applied to the valve for a short time. The valve will stop for approximately a second. During this time the sieve bed pressures are equalized.
4. A short DC voltage signal is again applied to the valve. The valve will stop for several seconds causing the left bed to pressurize while the right bed depressurizes.
5. A short DC voltage signal is again applied to the valve. The valve will stop for approximately a second. During this time, the sieve bed pressures are equalized.
6. The cycle then repeats with step 2.

**NOTE**– In the “turn-down” mode, the fixed cycle time is decreased to less than 2 seconds.

## LOW PRESSURE SYSTEM

Changes were made to the 525 series that reduced the internal system pressure approximately 4 to 5 psi. These changes were implemented in production for all 525 models starting in December, 2019. The change to a lower pressure system reduces internal temperatures and increases component life.

Starting serial numbers for units with the low pressure system:

- 525DS .....B19C060100DS
- 525DS-Q .....B201130001DQ
- 525KS .....B201020001KS
- 525KS-LT .....Not available at this time.
- 525PS .....B203040001PS

### Changes include:

1. PC board was reprogrammed to shorten the cycle time from 3.6 to 2.9 seconds. The shorter cycle time results in lower accumulator tank pressures as compared to previous units. Therefore it is important to reference the accumulator tank pressure range chart when measuring tank pressures. See revised pressure range chart below. Note that pressures are slightly lower for units that have the low pressure system.
2. A new purge manifold is being used. Internal dimensional changes were made for the low pressure system. The new manifold has a white top making it easy to recognize.
3. An orifice was added to the tubing connected to the auxiliary oxygen port on all units having the lower pressure system.

The changes to the parts above require different part numbers. The part numbers listed below are used only in low pressure system units. Always refer to the parts list in this manual when ordering service parts.

- 525DD-638 PC board
- 525DD-618 Purge manifold w/white top
- 525DD-645 Auxiliary oxygen port tubing w/orifice

**NOTE** – When servicing 525 models, low pressure system units can be identified by serial number and manifold color.

TYPICAL PEAK ACCUMULATOR TANK PRESSURE RANGE @ 5LPM				
Altitude	Original System		Low Pressure System	
	PSI	kPa	PSI	kPa
0 to 457 m 0 to 1500 ft.	23-32	159-221	18-27	124-186
457 to 914 m 1500 to 3000 ft.	21-29	145-200	16-25	110-172
914 to 1524 m 3000 to 5000 ft.	20-27	138-186	13-24	90-165

There will be a pressure swing during each cycle.

- 4 – 5 psi on original system
- 3 – 4 psi on low pressure system

# TROUBLESHOOTING

## SIMPLIFIED TROUBLESHOOTING

The key to simple troubleshooting is to recognize which type of problem exists and select the most effective approach to solving the problem. The different types of problems and the approaches for solutions are as follows:

### Type I—Purity Issues (Low Oxygen Indicator Light and/or an audible alert is activated or the Pressure Relief Valve releases pressure with a ‘popping’ sound).



#### WARNING

Electric Shock Hazard. Extra care should be taken if it is necessary to operate the unit with the cabinet removed.



#### WARNING

Mechanical Hazard. Keep fingers, loose clothing, etc. away when working on compressor.

### Observe the pressure cycle at the oxygen tank.

1. Connect a calibrated pressure gauge to the unit's oxygen tank test point or manifold. See accumulator pressure test on page 18.
2. Set the unit's flow meter to 5 LPM.
3. Power the unit and allow it to operate for a minimum of 5 minutes before observing the pressure cycle.
4. Compare the high pressures and low pressures to those expected for the current elevation and use the following chart to find the appropriate action. All consecutive high pressures should be within 2 psi of each other and all consecutive low pressures should be within 2 psi of each other.

**NOTE**– For normal system pressures refer to Specifications.

**NOTE**– Check for leaks using a certified leak detection solution such as Snoop® or equivalent (must not contain ethylene glycol). Apply leak test solution to all fittings and hose connections with unit running. If an air leak is present, the solution will bubble. All leaks should be repaired before putting the unit back in service.



#### CAUTION

Do not apply leak test solution to any part of the rotary valve or the main PC Board assembly.

### Pressure Diagnostic Chart

If Pressure Reading Is	Do This	To This
Higher than expected and/or pressure relief valve has a ‘popping’ noise	Replace	Sieve beds (2)
Lower than expected	Inspect and replace, as needed	Filters
	Inspect and correct or replace, as needed	Tubing connections
	Troubleshoot	Compressor See Component Testing, Repair and Replacement
As expected	Inspect and correct, as needed	Leaks from sieve beds to oxygen outlet port
Dropping too low during cycle change	Replace	Check valves or manifold
Uneven - high pressures & low pressures are not consistent during cycle	Inspect and replace, as needed	Rotary valve wire harness
	Troubleshoot or replace	Rotary valve or PC board. See Component Testing, Repair and Replacement

### Type II—Operation Issues (Service Indicator Light and/or an audible alert is activated or the Pressure Relief Valve releases pressure with a ‘popping’ sound)



#### WARNING

Electric Shock Hazard. Extra care should be taken if it is necessary to operate the unit with the cabinet removed.



#### WARNING

Mechanical Hazard. Keep fingers, loose clothing, etc. away when working on compressor.

**NOTE**– Check for leaks using a certified leak detection solution such as Snoop® or equivalent (must not contain ethylene glycol). Apply leak test solution to all fittings and hose connections with unit running. If an air leak is present, the solution will bubble. All leaks should be repaired before putting the unit back in service.



#### CAUTION

Do not apply leak test solution to any part of the rotary valve or the main PC Board assembly.

### Operation Alarm Chart

If this is happening	It's because of this	Do this to resolve
Pressure relief valve has a ‘popping’ noise with possible uneven tank pressure.	Rotary valve not cycling properly.	Test rotary valve. Refer to page 25.
	Defective sieve beds.	Replace sieve beds.
Continuous red light with a pulsing audible alert while compressor is operating.	Low flow alert – flow setting below 0.5 lpm.	Correct setting and educate user and / or install low flow meter if prescription is below 1 lpm. See section on the flow meter.
Continuous red light with a continuous audible alert and unit is warm to touch.	Internal temperature is too high.	Move unit to cooler location.
		Ensure unit vents are clear.
		Ensure unit filters are clean.
		Ensure cooling fan is operating, replace as needed.
Ensure there is proper voltage to the unit. If voltage is correct, replace capacitor or compressor.		
Continuous red light with a pulsing audible alert and fan is operating but compressor is not.	Internal power failure to compressor.	Test voltage at compressor connector. If no voltage, replace main wire harness. If voltage present, replace capacitor or compressor.
Blinking red light with a pulsing audible alert and compressor and fan not operating. <b>NOTE</b> – Serial numbers starting with B will have audible only.	External OR Internal power failure.	Ensure voltage is correct and / or the part is functional for the following: AC outlet, power cord, IEC connector or cord connection, main wire harness, circuit breaker; correct as needed. If issue persists, replace power switch.
Blinking red light with a pulsing audible alert and compressor and fan are operating. Pressure relief valve has a ‘popping’ noise.	Internal power failure at valve wire harness or PC board.	Inspect wire harness and replace as needed. Inspect fuse, if blown, replace PC board. <b>NOTE</b> – Serial numbers starting with B, replace PC board.

### Type III—The concentrator runs and continues to cycle but has low oxygen concentrations and no alarms are activated.

This problem is similar to Type I in the way it is diagnosed/resolved. Observe pressure cycle at oxygen tank as recommended in Type I.

# TROUBLESHOOTING

## TROUBLESHOOTING CHART A

Visible Alarm	Audible Alarm	Compressor
OFF	OFF	ON
OTHER SYMPTOMS	POSSIBLE CAUSE	POSSIBLE REMEDY
Pulsating air noise	Intake filter not in place or defective	Check filter and replace if necessary
	Compressor intake hose disconnected	Reconnect hose
Excessive noise	Loose or defective motor mounts	Replace motor mounts
	Defective compressor	Replace compressor
	Defective cooling fan	Replace cooling fan
Fluctuating oxygen flow	Occluded humidifier	Clean or replace humidifier
	Use of improper humidifier	Use only a bubble-type humidifier
	Occluded filters	Clean or replace filters
	Occluded or defective cannula and tubing	Detach cannula from oxygen delivery tubing. If proper flow is not attained, check tubing for kinks or other obstructions. Clean or straighten as required or replace tubing if necessary
	Use of excess oxygen tubing	The unit is designed to deliver 5 lpm with a cannula on 50 feet (15 meters) of approximately 5/32" (4 mm) inside diameter tubing. Smaller diameter tubing or the addition of any other flow restriction may prevent obtaining the desired flow rate.
	Defective flow meter	Replace flow meter
	Leak in system	Check for leaks in all hoses and fittings
	Defective compressor	Replace compressor
	Defective compressor reed valve	Replace compressor reed valve
	Defective check valve	Replace check valve or manifold
	Pressure regulator not adjusted properly or defective	Adjust or replace pressure regulator
Little or no oxygen flow	Flow meter not adjusted properly	Adjust flow meter
	Hose disconnected to flow meter	Reconnect hose
	Oxygen delivery tubing is kinked or blocked	Straighten tubing or remove obstruction
	Occluded humidifier	Clean or replace humidifier
Low oxygen concentration	Leak in system	Check for leaks in all hoses and fittings
	Defective sieve bed check valve	Replace check valve or manifold
	Defective compressor reed valve	Replace compressor reed valve
	Defective compressor	Replace compressor
	Rotary valve not operating correctly	Replace valve
	Occluded filters	Clean or replace filters
	Contaminated sieve beds	Replace sieve beds
Audible alarm does not sound during power failure	Unit has not been used for an extended period of time. <b>NOTE</b> – If the concentrator has been unused for an extended period, the unit must run several minutes before the power fail alarm will activate.	Allow unit to run for 20 minutes and retry
	Defective PC board	Replace PC board
	Defective power switch	Replace power switch
	Defective wire harness	Replace wire harness
Audible alarm does not sound when unit is turned "On"	Defective PC board	Replace PC board
Pressure relief valve activated – "popping" sound	PC board connectors not properly latched	Be sure tabs are pushed completely into place
	Defective PC board	Replace PC board
	Defective rotary valve	Replace valve
Service Required light does not illuminate when unit is turned "On"	PC board connectors not properly latched	Be sure tabs are pushed completely into place
	Defective PC board	Replace PC board
	Defective light panel	Replace light panel (N/A for serial numbers starting with B)

# TROUBLESHOOTING

## TROUBLESHOOTING CHART B

Visible Alarm	Audible Alarm	Compressor
BLINKING	PULSING	OFF
OTHER SYMPTOMS	POSSIBLE CAUSE	POSSIBLE REMEDY
Fan off	Line cord not properly installed or defective	Insert plug in receptacle or replace line cord. On 220/230/240 Volt units, check that the IEC connector on the back of the unit is attached.
	No power at receptacle	Check building circuit breaker or fuse, or have house wiring checked by qualified electrician. Circuit may be fully loaded with other appliances and another receptacle may be required.
	Oxygen concentrator circuit breaker activated	Press the circuit breaker reset button. If unit circuit breaker opens again, check internal wiring.
	Line cord quick-connect terminal inside unit is disconnected	Reconnect quick-connect terminal
	Defective power switch	Replace power switch
	Defective circuit breaker	Replace circuit breaker

## TROUBLESHOOTING CHART C

Visible Alarm	Audible Alarm	Compressor
BLINKING	PULSING	ON
OTHER SYMPTOMS	POSSIBLE CAUSE	POSSIBLE REMEDY
Fan and compressor operating Pressure relief valve activated – “popping” sound	Connector on PC board not connected	Connect connector
	Blown fuse on PC board	Replace PC board (N/A for serial numbers starting with B)
	Defective PC board	Replace PC board
	Defective valve or valve wire harness.	Replace valve or valve wire harness

## TROUBLESHOOTING CHART D

Visible Alarm	Audible Alarm	Compressor
ON	ON	OFF
OTHER SYMPTOMS	POSSIBLE CAUSE	POSSIBLE REMEDY
Fan operating	Main wiring harness disconnected/defective	Reconnect/replace wiring harness
	Loose compressor wire	Tighten or attach wire
	Defective capacitor	Replace capacitor
	Defective compressor	Replace compressor
Unit warm to the touch and cannot be restarted for several minutes	Compressor overheated due to: <ol style="list-style-type: none"> <li>1. Occluded filters</li> <li>2. Restricted input or output air passage</li> <li>3. Low or high line voltage</li> </ol>	<ol style="list-style-type: none"> <li>1. Clean or replace filters</li> <li>2. Remove obstruction</li> <li>3. Check line voltage; use alternate circuit independent of other appliances</li> </ol>
	Defective cooling fan	Replace cooling fan
	Defective compressor	Replace compressor

# TROUBLESHOOTING

## TROUBLESHOOTING CHART E

Visible Alarm	Audible Alarm	Compressor
ON	ON	ON
OTHER SYMPTOMS	POSSIBLE CAUSE	POSSIBLE REMEDY
Fluctuating or no flow	System pressure below 9 psi (62.1 kPa) due to:	
	1. Leak in system	1. Check for leaks in all hoses and fittings
	2. Defective compressor	2. Replace compressor

## TROUBLESHOOTING CHART F

Visible Alarm	Audible Alarm	Compressor
SEE BELOW	SEE BELOW	ON
OTHER SYMPTOMS	POSSIBLE CAUSE	POSSIBLE REMEDY
No OSD lights are illuminated.	Defective OSD.	Check concentration with an oxygen analyzer. If the concentration is within specification, replace the PC board.
Red "Service Required" light is illuminated accompanied by a beeping audible alarm	Oxygen level is low*	Check concentration with an oxygen analyzer. If the concentration is within specification, replace the PC board. If the concentration is low, refer to low oxygen concentration symptom in Troubleshooting Chart A.
	Defective OSD (for serial numbers starting with B)	Replace PC board.
Yellow Low Oxygen Light and the Red Service Required Light are illuminated accompanied by a beeping audible alarm.	Defective OSD	Replace PC board.
	Oxygen level is low* (for serial numbers starting with B)	Check concentration with an oxygen analyzer. If the concentration is within specification, replace the PC Board. If the concentration is low, refer to low oxygen concentration symptom in Troubleshooting Chart A.
Yellow Low Oxygen light is illuminated.	Oxygen level is low*	Check concentration with an oxygen analyzer. If the concentration is within specification, replace the PC board. If the concentration is low, refer to low oxygen concentration symptom in Troubleshooting Chart A.
Yellow Low Oxygen light is illuminated and an intermittent audible alarm sounds every few seconds.	Oxygen level is low*	Check concentration with an oxygen analyzer. If the concentration is within specification, replace the PC board. If the concentration is low, refer to low oxygen concentration symptom in Troubleshooting Chart A.

\*Refer to Alerts page for oxygen purity levels.

**NOTE**– If unit does not run or perform to specification, verify the proper AC input voltage and frequency are being used.

## PROPER REPAIR PROCEDURES



### WARNING

When servicing the DeVilbiss Oxygen Concentrator, be absolutely certain that the correct tools are used and that the parts are free of oil and grease or any material not compatible with oxygen. Teflon® tape is recommended and must be applied to the male threads omitting the first thread to eliminate the possibility of tape particles entering the oxygen system.

Electric shock hazard. Do not remove cabinet. The cabinet should only be removed by a qualified DeVilbiss homecare provider.

Disconnect the power cord from the wall outlet before attempting repairs on the unit. Extra care should be taken if it is necessary to operate the unit with the cabinet removed.

**NOTE**– Be sure to read all of the steps involved before beginning any of the procedures in this manual.

**NOTE**– After repairing or replacing a component, run the unit for 20 minutes, check the oxygen concentration and test for leaks.

The DeVilbiss Oxygen Concentrator is designed for ease of service. To aid service personnel a Service Kit (part #444-501) is available which contains the necessary gauges, tools, and testing instruments to properly service the oxygen concentrator. See list below.

In addition, you will also need an oxygen analyzer (part #R217P62) to periodically check oxygen concentration levels and leak test solution.



### WARNING

A certified leak detection solution, such as SWAGELOK #MS-Snoop® or equivalent, is needed to test for system leaks. The solution must not contain ethylene glycol.



### CAUTION

Do not apply leak test solution to any part of the rotary valve or the main PC Board assembly.

**NOTE**– Apply leak test solution to all fittings and hose connections with the unit running. If an air leak is present, the solution will bubble. All leaks should be repaired before putting the concentrator back in service.

The following parts are included in the Service Kit:

1	Slotted bit
1	#1 Phillips bit
1	#2 Phillips bit
1	Crescent wrench
1	8" Duckbill pliers
1	Voltmeter
2	Pressure/Vacuum gauge
1	Tool box
2	Test fittings
1	Torx screwdriver w/bits
1	Channel Lock pliers
1	1/4" Ratchet wrench
1	10mm Socket 1/4 Drive
1	1/4" Drive extension
1	Plastic storage case

## CABINET REMOVAL

### For units with Serial Numbers starting with B, J, N or R

#### To remove back cabinet:

The majority of all the servicing and repairs can be done without removing the front cabinet completely. However, it may be loosened or removed to gain access to the components behind it.

1. Unplug the unit from the wall outlet.
2. Remove the six screws that secure the back cabinet – 2 behind handle, 2 near the bottom, and 1 on each side.

**NOTE**– All six screws are the same size.

3. Remove the back cabinet by sliding it toward the rear until clear.
4. To reassemble, reverse steps 2-3.

#### To loosen the front cabinet:

5. Remove the two screws (located directly above the hour meter) that hold the front cabinet to the unit's internal structure.
6. Remove the screw located near the bottom of the recessed humidifier compartment on the front of the unit. The top of the front cabinet can now be tilted forward to allow access to the components behind it.

#### To remove the front cabinet completely:

7. Tilt cabinet forward and disconnect the ribbon connector from the PC board. Units with serial numbers starting with B do not have a ribbon connector.
8. Before disconnecting the wires from the power switch and circuit breaker note their positions in order to reconnect them properly; then disconnect the wires.
9. Disconnect the hose at the bottom of the flow meter and remove cabinet.
10. To reassemble reverse steps 5 – 9 making sure bottom of cabinet is inserted securely in base of unit.

**NOTE**– Two types of cabinet screws have been used in the 525 models during the past several years, thread-forming screws and machine screws. Take care not to overtighten the thread-forming screws; they should be torqued to 18 – 20 in-lbs. The machine screws have much finer threads and are used in conjunction with brass inserts that are molded into the cabinet part; they should be torqued to 20 – 25 in-lbs.

When replacing a cabinet part such as the front cover, base or compressor box be sure to use the correct screw. The fine threaded machine screws should always be used if there is a brass insert. Thread-forming screws should be used if there is no brass insert molded into the cabinet part.

These screws are not interchangeable, so be sure to order the correct part number. See figure below.



### For units with Serial Numbers starting with F

#### To remove front and back cabinets:

1. Ensure the unit is unplugged from the wall outlet.
2. Remove the six screws that secure the back cabinet – 2 behind handle, 2 near the bottom, and 1 on each side.

**NOTE**– All six screws are the same size.

3. Remove the back cabinet by sliding it toward the rear until clear.
4. Remove the front cabinet by pushing the top shoulders toward the back of the unit, then outward away from behind the bib. Tilt the top of the front cabinet forward until it can be pulled out of the base of the unit.

# COMPONENT TESTING, REPAIR AND REPLACEMENT

5. To reassemble, reverse steps 2-4.

The majority of all the servicing and repairs can be done without removing the front bib. However, it may be loosened or removed to gain access to the components behind it.

### To loosen the bib:

6. Remove the two screws (located directly above the hour meter) that hold the bib to the unit's internal structure. The bib can now be tilted forward to allow access to the components behind it.

### To remove the bib completely:

7. Disconnect the ribbon connector from the PC board.
8. Before disconnecting the wires from the power switch and circuit breaker note their positions in order to reconnect them properly; then disconnect the wires.
9. Tilt the top of the bib forward to release it from the slot in the body of the concentrator.
10. Disconnect the hose at the bottom of the flow meter and remove bib.
11. To reassemble reverse steps 6 – 10 making sure bottom of front cabinet is inserted securely in base of unit.

**NOTE**– The bib tab must be inserted into the slot above the rotary valve before securing bib.

**NOTE**– Two types of cabinet screws have been used in the 525 models during the past several years, thread-forming screws and machine screws. Take care not to overtighten the thread-forming screws; they should be torqued to 18 – 20 in-lbs. The machine screws have much finer threads and are used in conjunction with brass inserts that are molded into the cabinet part; they should be torqued to 20 – 25 in-lbs.

When replacing a cabinet part such as the front cover, base or compressor box be sure to use the correct screw. The fine threaded machine screws should always be used if there is a brass insert. Thread-forming screws should be used if there is no brass insert molded into the cabinet part.

These screws are not interchangeable, so be sure to order the correct part number. See figure below.



## ACCUMULATOR PRESSURE TEST

### To check accumulator pressures:

1. Make sure the unit is "Off."
2. Use the Cabinet Removal instructions listed previously to open the unit for testing.
3. Use the pressure gauge (part #PVO2D-601) and pressure test assembly (part #303DZ-637) included in the Service Kit.

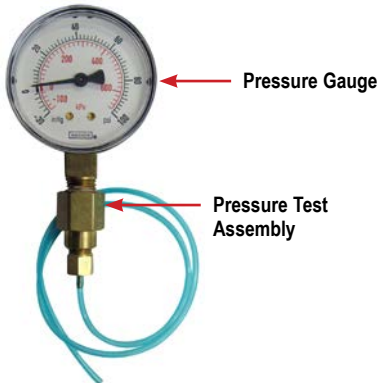

4. Remove the tubing cap from the accumulator tank fitting or from the manifold attached to the tank, and attach the 1/16" (1.6 mm) diameter tubing from the gauge to the fitting just vacated above.

**NOTE**– Some manifolds may have a 1/8" ID fitting. In such cases, a 1/16" to 1/8" adapter (part #525DD-637) will be needed in order to connect the gauge to the manifold fitting.

See Figures below showing pressures being checked at accumulator tank "T" fitting and manifold.



Accumulator "T" Fitting

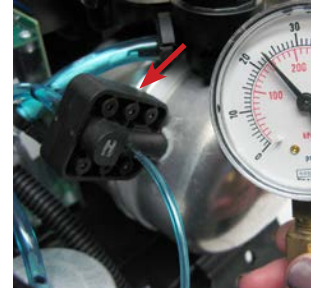

Manifold

5. Turn the unit "On" with the flow rate set to maximum recommended flow, which is 5 lpm. Allow the unit to run for 5 minutes before observing the pressures. During each timed cycle, the average pressure in the oxygen accumulator will rise and fall. The high pressures should be consistent and the low pressures should be consistent.

**NOTE**– Expected normal pressures observed depend on altitude and flow rate. See the Expected Accumulator Tank Pressure Range chart below.

- Increases in altitude and flow rate will slightly decrease accumulator pressures.
- Lower altitudes and flow rates will slightly increase accumulator pressures.

**NOTE**– A defective check valve, in either the purge harness or the manifold, may cause a rapid drop in accumulator pressure below the minimum value.

TYPICAL PEAK ACCUMULATOR TANK PRESSURE RANGE @ 5LPM				
Altitude	Original System		Low Pressure System	
	PSI	kPa	PSI	kPa
0 to 457 m 0 to 1500 ft.	23-32	159-221	18-27	124-186
457 to 914 m 1500 to 3000 ft.	21-29	145-200	16-25	110-172
914 to 1524 m 3000 to 5000 ft.	20-27	138-186	13-24	90-165

There will be a pressure swing during each cycle.

- 4 – 5 psi on original system
- 3 – 4 psi on low pressure system

6. Refer to the Type 1 – Purity Issues, found under Simplified Troubleshooting, to determine the appropriate action to take in resolving abnormal pressure cycles.

**NOTE**– A defective compressor will be indicated by slowly rising pressure. Pressure may only reach a certain level and then stop.

Low oxygen concentration levels and accumulator pressures higher than normal may indicate defective sieve beds. Severely contaminated beds may also cause the pressure relief valve on the compressor to open.

**NOTE**– A malfunctioning rotary valve may also cause high accumulator tank pressure and activation of the pressure relief valve. In this case it should be determined whether the problem is with the sieve beds, valve, or both.

## AUXILIARY OXYGEN PORT

All 525 series concentrators are now being manufactured with an auxiliary oxygen port located on the back of the unit. Concentrators with the auxiliary port have serial numbers starting with B, N or R.

### To fill oxygen cylinders:

This external port can be used to fill oxygen cylinders with an FDA-cleared cylinder filling device that is designed to use oxygen from a concentrator to fill a cylinder. The port is only for use with FDA-cleared filling devices with compatible oxygen input specifications. The flow meter should be set at 3 LPM or less when the concentrator is being used during cylinder fill. The port does not affect concentrator performance if properly used. See figures below.

### Auxiliary Port Output Specifications:

Outlet Pressure ..... <15 psi  
 Outlet Flow ..... 2 LPM  
 Outlet Oxygen ..... >90%  
 Operation Time ..... Continuous

Refer to the cylinder filling device instruction guide for the oxygen input/output specifications, connection and operating instructions.

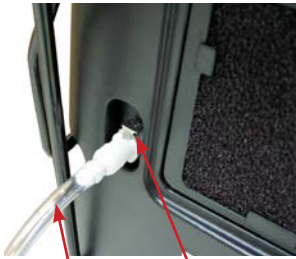

Transfill Hose (PF1100TUB) Auxiliary Port



Transfiller Caddy (525DD-650)



### WARNING

When using the Transfiller Caddy with a Transfill device, always keep the system on a flat surface. Disassemble the system prior to moving.

## CAPACITOR

The capacitor enables the compressor to start and run by supplying voltage to the windings of the compressor motor. A defective capacitor will result in the compressor running slower or not starting.



### CAUTION

The 525DS concentrators use a GSE compressor with a 22 mfd capacitor. If replacement is necessary, be sure the correct capacitor is installed.



### CAUTION

The 525KS/525PS concentrators use a GSE compressor with a 10 mfd capacitor. If replacement is necessary, be sure the correct capacitor is installed.



### WARNING

Electric Shock Hazard. When replacing the capacitor, do not touch the terminals or allow metal objects to come in contact with the terminals on the capacitor. The capacitor may hold a charge for several days after the unit is turned off.

If a defective capacitor is suspected, a new one must be installed. The capacitor is strapped into a well molded into the bottom of the unit next to the cooling fan.

## To replace the capacitor:

1. Make sure the unit is unplugged from the wall outlet.
2. Remove the back cabinet. Use the Cabinet Removal instructions listed previously.
3. Remove the compressor. Use the To Remove the Compressor instructions listed under Compressor.
4. Disconnect the two wires from the terminals on the capacitor.
5. Cut the nylon cable tie holding the capacitor in place and remove the capacitor.
6. Reconnect the wires to the new capacitor.
7. Install the new capacitor and secure with a new cable tie.
8. Replace the compressor and reassemble cabinet.
9. Replace the back cabinet and secure with the six screws.

## CHECK VALVES/MANIFOLD

### Manifold And Sieve Bed Check Valves

The manifold check valves, located in the manifold attached to the accumulator tank, and the sieve bed check valves, located in the purge harness between the outlet of each sieve bed and the accumulator tank, allow oxygen to pass from the sieve beds to the accumulator tank when the bed pressure is greater than the accumulator tank pressure. These valves also prevent reverse flow of oxygen from the accumulator tank to the sieve beds.

The manifold also directs a small amount of pressurized oxygen into the discharging sieve bed to aid the nitrogen exhaust process. The purge harness includes a fixed orifice that performs the same function.

A defective manifold or sieve bed check valve will result in lower oxygen concentrations and accumulator pressures.

Use the Accumulator Pressure Test listed previously to troubleshoot manifold or sieve bed check valves.

- To replace a defective sieve bed check valve, remove the tubing on either side of it and install a new valve making sure the outlet end is toward the accumulator tank.
- To replace a defective manifold check valve, replace the manifold.

**NOTE**— Also see *Manifold* section on page 23.

### Final Check Valve

The final check valve is located, on older units, between the final bacteria filter and the oxygen outlet fitting.

#### To replace the final check valve:

1. Make sure the unit is unplugged from the wall outlet.
2. Use the Cabinet Removal instructions listed previously to open the unit.
3. Remove the hose from the outlet side of the final bacteria filter.
4. Remove the two screws from the back of the oxygen outlet fitting assembly and remove the assembly.
5. Remove the hose from each end of the final check valve.
6. Attach the hoses to a new check valve. Make sure that the flat side of the check valve is directed toward the oxygen outlet fitting.
7. Replace the outlet fitting assembly and connect the hose to the filter.
8. Reassemble the cabinet.

# COMPONENT TESTING, REPAIR AND REPLACEMENT

## COMPRESSOR

The DeVilbiss Oxygen Concentrator uses a GSE or Thomas double-head, oil-free compressor. The compressor is secured to the base with four motor mounts.

### GSE Compressor

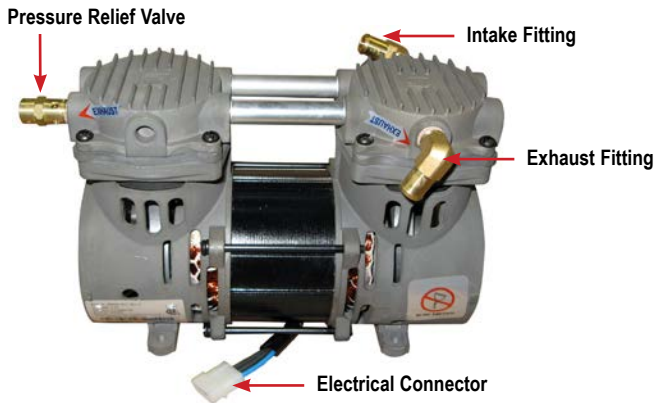

### Thomas Compressor

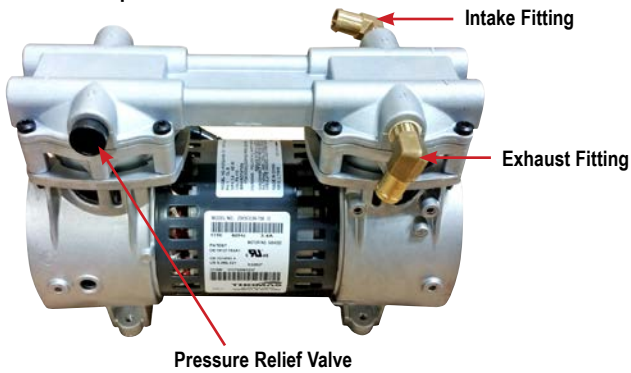

These components are included in the Compressor Rebuild Kit (GSE 525D-643 and 525K-643 or Thomas 525D-653). GSE compressor is shown below.

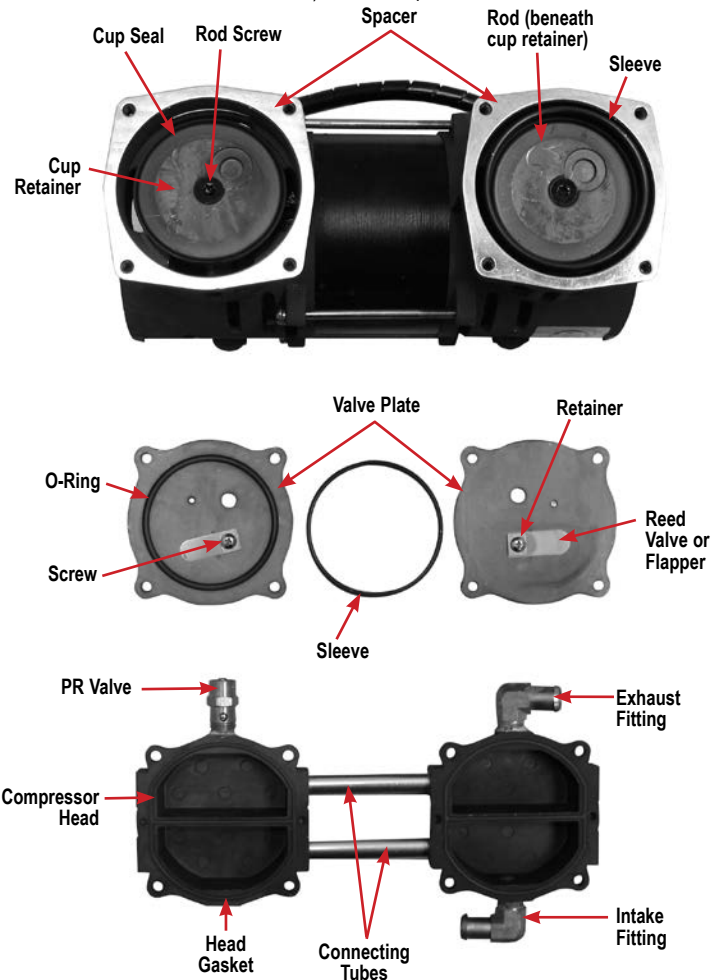

A compressor that is worn or defective may:

- cause pressure to rise slowly.
- cause excessive noise and/or vibration.
- cause lower oxygen concentrations.

A worn or defective compressor can be caused by a defective internal component such as:

- reed valve
- o-ring
- gasket
- cup seal

**NOTE**– A built-in thermal cutoff switch will shut the compressor off if it becomes overheated. This protects the compressor from damage caused by heat build-up. (Some models have an auxiliary thermostat mounted within the compressor compartment.) Should this condition occur, the compressor will require several minutes for the thermo-protective device to reset.

**NOTE**– A pressure relief (PR) valve is located on the pressure head to prevent high pressure build up in the system should a component malfunction occur.

### To test the compressor operating voltage:

The compressor requires line voltage to operate. If the compressor does not start when the unit is turned on, the voltage input must be tested:

1. This voltage can be checked at the compressor connector using a voltmeter or test light connected to the brown and blue wires. The voltmeter is the best way to test.

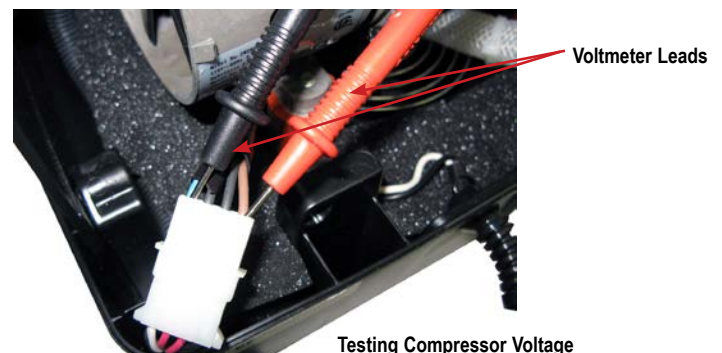

# COMPONENT TESTING, REPAIR AND REPLACEMENT

2. If no voltage is detected, disconnect power and check for loose or broken wires between the compressor connector and switch or wire harness.
3. If there is voltage at the compressor connector, then either the capacitor or the compressor itself is defective.

## To test the compressor for proper output:

**NOTE**— If the compressor is not providing a high enough output the patient alert system may be activated.

1. Use the Cabinet Removal instructions listed previously to open the unit for testing.
2. Use the Accumulator Pressure Test listed previously to observe the high pressures, low pressures and the pressure drop.
3. Refer to the Type 1 – Purity Issues, found under Simplified Troubleshooting, to determine the appropriate action to take in resolving abnormal pressure cycles.

**NOTE**— A compressor, which slowly builds pressure that remains below 25 psi, indicates worn cup seals and/ or reed valves.

## If these conditions are observed then:

- The unit filter(s) may be occluded—check the air filter, compressor filter, and intake filter for occlusions.
- There may be a severe leak in the system—check for air leaks using a leak detection solution such as Snoop® or equivalent (must not contain ethylene glycol).



### CAUTION

Do not apply leak test solution to any part of the rotary valve or the main PC Board assembly.

- The compressor reed valves, cup seal, or the compressor itself may be defective.

If the filters are not occluded and no leaks are found, the compressor must then be removed and repaired or replaced.

## To remove the compressor:

1. Make sure the unit is unplugged from the wall outlet.
2. Use the Cabinet Removal instructions listed previously to open the unit.
3. Disconnect the compressor wires by disconnecting the compressor electrical connector.
4. Remove the ladder clamp and hose from the exhaust fittings on the compressor head and compressor filter if applicable.
5. Carefully place the concentrator on its front side. From the bottom of the unit, remove the four 10 mm hex nuts that secure the motor mounts.
6. Lift compressor partially out of the compressor housing area and loosen ladder clamp securing hose to the intake fitting, then remove hose.
7. Compressor may now be removed from the compressor housing area.



### CAUTION

If the unit has been running recently, the compressor may be hot.

8. Unscrew motor mounts from compressor feet by hand.

## To inspect and/or replace internal components:

1. Remove the eight screws that hold the compressor heads in place. When removing the heads, be sure to keep each head and its components with the correct compressor side.
2. Check for proper placement of or damage to the gaskets on the bottom of the compressor heads. Replace if damaged.
3. Remove reed valve plates. A reed valve is located on each side of the valve plate.

4. The compressor reed valves should be flush with the valve plate. If the valve is broken or not flush with the valve plate, or foreign matter is detected inside the head, clean or replace the compressor reed valves.

## To replace the compressor reed valves:

- a. Remove the screw holding the compressor reed valves in position on the valve plate and discard the used reed valves.
  - b. Position the new reed valves so that they are centered and completely cover the holes in the valve plate.
  - c. Place the metal retainer on the reed valves and secure with the reed valve screw.
5. Check for proper placement of or damage to the rubber o-ring on the bottom of the valve plate. Replace if damaged.
  6. Remove piston sleeves by pulling upward and inspect cup seal on pistons. Replace if badly worn or damaged.

## To replace cup seal:

- a. Remove rod screw from top of piston.
  - b. Remove the cup retainer plate.
  - c. Discard defective cup seal.
  - d. Place new cup seal into position.
  - e. Replace cup retainer plate.
  - f. Secure with screws.
7. Discard old sleeve and position new sleeve at 45 degree angle over the piston. Carefully push it down as you rotate it slightly around the top of the piston until it is in place.
  8. Place valve plates on the compressor so that heads of reed valve screws are aligned with the indentation in top of pistons.
  9. Install the compressor heads so that the holes in the heads are aligned with the holes in the compressor housing.
  10. Secure compressor heads with the screws.

## To replace the compressor:



### CAUTION

The 525DS concentrators use a GSE or Thomas compressor with a 22 mfd capacitor. The 525KS/525PS concentrators use a GSE compressor with a 10 mfd capacitor. If replacement is necessary, be sure the correct capacitor is installed.

1. Inspect the motor mounts. Replace if damaged. Attach mounts to compressor feet.
2. Inspect the capacitor to determine if replacement is necessary. If capacitor is wrong value for compressor or replacement is desired, refer to Capacitor section.
3. Reconnect hose to the compressor intake fitting.
4. Position compressor on the base of the unit so that the studs on the motor mounts protrude through the holes in the base of the unit.
5. Secure motor mounts with hex nuts.
6. Reconnect hoses to the fittings at compressor exhaust and filter.
7. Reconnect the compressor electrical connector.

## COOLING FAN

The cooling fan provides a constant air flow to cool the compressor. The cooling fan is located in the bottom of the unit below the compressor.

A defective cooling fan may cause the compressor's internal thermo-protective (thermal cut off) device to activate and shut the compressor off. Should this condition occur, the compressor will require several minutes for the thermo-protective device to reset.

## If the cooling fan is defective, it must be replaced:

1. Make sure the unit is unplugged from the wall outlet.
2. Use the Cabinet Removal instructions listed previously to open the unit.
3. Use the To Remove the Compressor instructions listed under Compressor.
4. Disconnect the cooling fan terminals.
5. Note the position of the fan and fan guard before removing the four retaining screws that secure the fan to the base of the unit.
6. Remove the defective fan and secure the replacement fan in position with the four retaining screws.

**NOTE**– When installing the fan, be sure the air flow directional arrow on the side of the fan is directed away from the compressor and fan guard is reinstalled properly.

7. Reconnect the electrical connector.
8. Reinstall the compressor.

## FLOW METER

There are two flow meters available for the DeVilbiss 525 series oxygen concentrators: a standard 5 lpm flow meter (505DZ-607) and a low output flow meter (515LF-607). The low output flow meter should be used when the prescribed flow rate is at or under 1 lpm.

**NOTE**– Installation of a low output flow meter eliminates the low flow alert for flow delivery under 0.5 lpm and prevents the device from meeting the requirements of ISO-80601-2-69:2014 Section 201.13.2.101.



Locking Screw

Both pressure-compensated flow meters have an accuracy level of  $\pm 5\%$  at full scale (exception:  $+0\%$  /  $-5\%$  at 5 lpm) and are designed for use at 8.5 psi (58.6 kPa). Both flow meters can be locked using a 1/16th inch Allen wrench and tightening the locking screw behind the flow meter knob.

## To check for leaks in the flow meter tubing:

1. Check for leaks using a certified leak detection solution such as Snoop® or equivalent (must not contain ethylene glycol).
2. Apply leak test solution to all fittings and hose connections with the unit running.



### CAUTION

Do not apply leak test solution to any part of the rotary valve or the main PC Board assembly.

3. If an air leak is present, the solution will bubble. All leaks should be repaired before putting the concentrator back in service.



### WARNING

Electric Shock Hazard. Use caution when leak testing near electrical connections.

## To replace the flow meter:

1. Make sure the unit is unplugged from the wall outlet.
2. Use the Cabinet Removal instructions listed previously to open the unit.
3. From behind the bib/front cabinet, remove the 2 hoses from the flow meter.
4. While squeezing tabs on flow meter brackets, push the flow meter through the bib/front cabinet or just unscrew flow meter fittings.
5. Install new flow meter and reconnect hoses.

## To install or replace the low output flow meter:

1. Ensure that the unit is unplugged from the wall outlet.
2. Use the Cabinet Removal instructions listed previously to open the unit.
3. Disconnect:
  - a. All wires, terminals and connectors attached to the PC board.
  - b. The 1/8 ID blue tubing from the Oxygen Sensing Device (OSD) and from the flow meter.
  - c. The screw that secures the PC board to the unit.
4. Build the T-fitting assembly. (Skip this step, if replacing an existing low output flow meter.)
  - a. Cut the existing 1/8 inch blue tubing that connected the OSD and the flow meter into two equal pieces.



- b. Attach each piece of the cut tubing to the large ends of the T-fitting, included in the kit.
  - c. Attach one end of the 1/16 inch ID blue tubing, included in the kit, to the small end of the T-fitting.
5. Position the bleed-off orifice and connect tubing.



Insert an opened paperclip through the hole in the case, behind where the PC board was installed (Fig. 1), until it appears in the filter cavity (Fig. 2).



Place the orifice fitting, included in the kit, onto the end of the paperclip (Fig. 3).

Push the fitting through the foam until it's inside the case. Remove the paperclip and attach the 1/16 inch ID tubing (Fig. 4).

6. Replace the flow meter.
  - a. Remove all tubing from the current flow meter.
  - b. Unscrew white plastic connectors or fittings.



# COMPONENT TESTING, REPAIR AND REPLACEMENT

- c. Remove the metal brackets and push the meter through the case. Save the meter and metal brackets for later use, if desired.
  - d. Align the new metal brackets on the flat surfaces of the new meter.
  - e. Push the flow meter into the case with the highest flow at the top.
7. Reassemble the unit.
- a. Connect one end of the 1/8 inch blue tubing to the T-fitting assembly to the bottom of the flow meter and the other end to the bottom of the OSD.
  - b. Reconnect the PC board wires, tubing, terminals and connectors.

## HOURLY METER

### To replace the hour meter:

1. Make sure the unit is unplugged from the wall outlet.
2. Use the Cabinet Removal instructions listed previously to open the unit.
3. Remove PC board.
4. Squeeze locking tabs on both sides of hour meter while pushing upward to remove meter.
5. Install a new hour meter by applying downward pressure until it snaps into position.
6. Replace PC board and reconnect all wires, connectors and tubing.



### CAUTION

Do not apply any force or flex the PC Board when connecting or disconnecting electronic or pneumatic components. Damage to the electronic assembly is possible.

### For units with Serial Numbers starting with B

The digital hour meter can be seen on the status indicator panel and is mounted directly onto the PC board. If the hour meter malfunctions, the PC board will need to be replaced.

Refer to PC board replacement instructions on page 25.

## MANIFOLD

The manifold is attached to the accumulator tank and performs the same function as a purge harness. It directs a small amount of pressurized oxygen into the discharging sieve bed to aid the nitrogen exhaust process while it ensures that the majority of pressurized oxygen is directed into the accumulator tank. The manifold also prevents reverse flow of oxygen from the accumulator to the sieve beds.

See CHECK VALVES: MANIFOLD and SIEVE in this manual for additional information.

## MOLECULAR SIEVE BEDS

The build and release of pressure in the sieve beds indicates the health of the sieve material and the operation of contributing components. Determine 'good' or expected pressures for your altitude by testing bed pressures on multiple oxygen concentrators that are producing at least 93% purity.

Check sieve bed pressures at the accumulator tank using the manifold test point or the accumulator tank test point. See Figures below.



Accumulator "T" Fitting

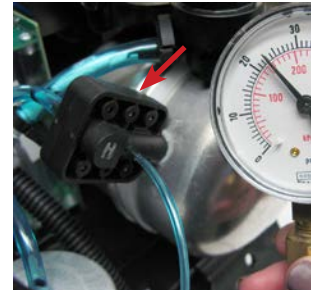

Manifold

**NOTE**– The pressure will rise and fall as it cycles through the rotary valve.

Also consider the acceptable pressure range for various altitudes as shown below.

TYPICAL PEAK ACCUMULATOR TANK PRESSURE RANGE @ 5LPM				
	Original System		Low Pressure System	
Altitude	PSI	kPa	PSI	kPa
0 to 457 m 0 to 1500 ft.	23-32	159-221	18-27	124-186
457 to 914 m 1500 to 3000 ft.	21-29	145-200	16-25	110-172
914 to 1524 m 3000 to 5000 ft.	20-27	138-186	13-24	90-165

There will be a pressure swing during each cycle.

- 4 – 5 psi on original system
- 3 – 4 psi on low pressure system

### To test sieve bed pressures:

1. Remove the plugged piece of 1/16" tubing from the manifold or the accumulator tank.
- NOTE**– Some manifolds may have a 1/8" ID fitting. In such cases, a 1/16" to 1/8" adapter (part #525DD-637) will be needed in order to connect the gauge to the manifold fitting.
2. Connect the pressure gauge to the test point and observe the cycling of pressures. Refer to the section on Normal Operating Sequence and also Accumulator Pressure Test.
  - a. If it is determined that the valve is not cycling the pressure, refer to the section on Rotary Valve testing.
  - b. If the unit is cycling properly, allow it to operate for 20 minutes.
3. After 20 minutes of operation, observe the high and low pressures and check the oxygen concentration level.
  - a. If the pressures are within the expected range and the oxygen concentration is within specification, the sieve material is effective.
  - b. If pressures are not within the expected range and/or the oxygen concentration is not within specification, refer to the Simplified Troubleshooting Table in this manual to determine the proper corrective action.

**NOTE**– If the molecular sieve material is found to be no longer effective, first search for the source of a malfunction in the system; then, for a cause for contamination (such as leaks) and take corrective action.

## To replace the molecular sieve beds:

**NOTE**– Make sure that the sealing caps remain on the new sieve beds until just prior to connecting hoses and tubing.

1. Ensure any contamination problem has been corrected.
2. Ensure the unit is unplugged from the wall outlet.
3. Cut the plastic cable ties that secure the sieve beds to the internal structure of the unit.
4. Remove the tubing from the fittings at the top of each sieve bed.
5. Remove the hose clamps and hose from the bottom of the sieve beds.
6. Install new sieve beds in reverse order using new plastic cable ties. Position the new beds so that the bed serial number label is at the top of the unit.
7. Leak test all connections with a certified leak detection solution such as Snoop® or equivalent (must not contain ethylene glycol). Apply leak test solution to all fittings and hose connections with unit running. If an air leak is present, the solution will bubble. All leaks should be repaired before putting the unit back in service.



### CAUTION

Do not apply leak test solution to any part of the rotary valve or the main PC Board assembly.

## POWER CORD

### To replace the power cord - 115 volt units only:

1. Make sure the unit is unplugged from the wall outlet.
2. Use the Cabinet Removal instructions listed previously to open the unit.
3. Disconnect the power cord connector.
4. Note wire colors and socket locations before removing wires.
5. Using a pair of duckbill pliers, squeeze the power cord strain relief and pull it out of the base of the unit.
6. Insert a new power cord through the hole in the base of the unit and secure with strain relief.
7. Insert sockets into connector housing and then reconnect the power cord connector.
8. Replace back cabinet and secure with the six screws.

## POWER SWITCH

### To replace the power switch:

1. Make sure the unit is unplugged from the wall outlet.
2. Use the Cabinet Removal instructions listed previously to open the unit.
3. Note the position of the wires and switch before removing the wires from the switch terminals.
4. While squeezing the locking tabs on the sides of the switch, push the switch out of the front of the unit.
5. Install the new switch in the correct orientation making sure that it locks into position.
6. Reconnect the wires to the switch terminals.

Switch Detail

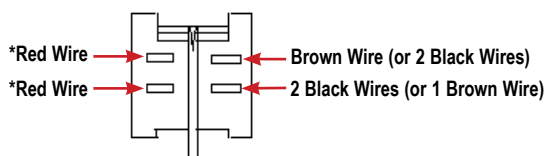

\*Either red wire can be connected to either left hand terminal of the switch

## PRESSURE REGULATOR

The pressure regulator stabilizes the flow of oxygen to the patient and establishes back pressure on the system. It is preset at 8.5 psi (58.6 kPa) and should not have to be adjusted in the field. It is not necessary to test the pressure regulator unless there is a problem with flow rate accuracy. The following test is only needed when troubleshooting flow rate issues.

### To test the pressure regulator:

1. Turn the unit "On."
2. Set the flow meter at 2 lpm.
3. Attach a pressure gauge (part #PVO2D-601) to the oxygen outlet to obtain a reference pressure. Use this reference pressure to determine if further testing is needed.
4. If the reference pressure varies from the expected pressure by more than  $\pm 0.5$  psi or  $\pm 5.9$  kPa, connect a 'T' fitting directly between the pressure regulator fitting and the pressure regulator tubing and attach the pressure gauge to the 3rd leg of the 'T' fitting. If the pressure reading is not within  $8.5 \pm .5$  psi ( $58.6 \pm 5.9$  kPa), adjustment to the pressure regulator is required.

### To adjust the pressure regulator:

1. If necessary, the pressure regulator can be adjusted by turning the allen screw on top of the regulator until the pressure is within specification. Turn clockwise to increase the pressure, and counterclockwise to decrease the pressure.

**NOTE**– Before adjusting the pressure regulator, make sure no leaks exist by using a certified leak detection solution such as Snoop® or equivalent (must not contain ethylene glycol).



### CAUTION

Do not apply leak test solution to any part of the rotary valve or the main PC Board assembly.

A malfunction in the pressure regulator will cause either a loss or fluctuation in the oxygen flow which will be seen on the flow meter or a decrease in oxygen concentration.

### To replace the pressure regulator:

1. Make sure the unit is unplugged from the wall outlet.
2. Use the Cabinet Removal instructions listed previously to open the unit.
3. Remove the tubing clamp and tubing from the pressure regulator.
4. Unscrew the regulator from the accumulator tank.
5. Install a new regulator on the accumulator tank and attach the tubing and tubing clamp.

## PRINTED CIRCUIT BOARD

The printed circuit (PC) board is responsible for monitoring and controlling the DeVilbiss Oxygen Concentrator.

The PC board has preset alerts for low flow and power failure. Should any of the alert values be exceeded, the patient alert system will activate.

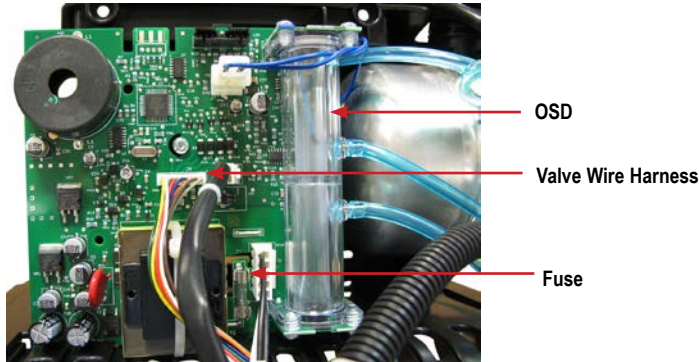

**For units with Serial Numbers starting with B, a different circuit board is used.**

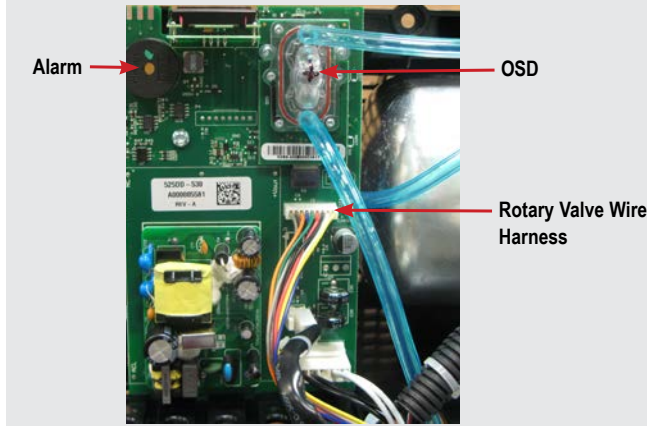

**NOTE**– If the concentrator has been unused for an extended period, the unit must run 20 minutes before the power fail alert will be enabled. This alert is powered by a capacitor on the PC board.



### CAUTION

Do not apply any force or flex to the PC Board when connecting or disconnecting electronic or pneumatic components. Damage to the electronic assembly is possible.

### To remove and replace the PC board:

1. Make sure the unit is unplugged from the wall outlet.
2. Use the Cabinet Removal instructions listed previously to open the unit.
3. Disconnect all wires and electrical connectors.
4. Remove the 1/8" (3.2mm) tubing from both fittings on the oxygen sensor.
5. Remove the screw that secures the board to the unit and remove the PC board.
6. Install the new PC board and secure it using the screw.
7. Reconnect all electrical wires, connectors and the tubing to the sensor.

## ROTARY VALVE

The timed rotary valve alternately distributes pressure supplied by the compressor to the sieve beds. While one bed is being pressurized the other bed is being exhausted through the valve exhaust port.

The valve contains two revolving discs powered by a stepper motor to cycle the pressure between the beds. DC voltage is supplied by the PC board to the motor windings causing the internal discs to turn and direct pressure to the proper sieve bed.

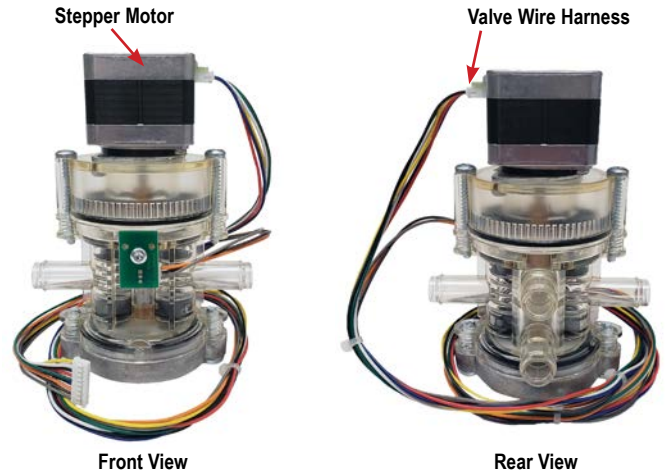

If the rotary valve is not shifting properly, one bed may pressurize continuously; the pressure building until the pressure relief valve on the compressor releases the excess with a sputtering sound.

There are several reasons why the rotary valve could malfunction; therefore the cause of failure must be determined before corrective action can be taken.

### To test the rotary valve:

1. Use the Cabinet Removal instructions listed previously to open the unit for testing.
2. Connect a pressure gauge to the test point on the manifold or accumulator tank to observe unit cycling and the high and low bed pressures. Refer to the section on Normal Operating Sequence and also Accumulator Pressure Test.
  - a. If it is determined that the valve is shifting properly and the high and low pressures are consistent, the valve is operating correctly.
  - b. If it is determined that the valve did not shift properly or the high pressures or low pressures are uneven, continue testing with step 3.

### For units with Serial Numbers starting with B

- c. If it is determined that the valve did not shift properly or the high pressures or low pressures are uneven, check the valve wire harness for any loose or broken connections. If harness connections are good, then the problem is caused by either the rotary valve or PC board.
 

Replace either the valve or the board with a known good part to determine exact cause of the problem.

Disregard step 3 below.

3. The stepper motor on the rotary valve has multiple windings so there are several voltage readings that need to be checked in order to determine if the problem is being caused by the PC board or the valve itself. Testing for proper voltage is done at the wire harness connectors on the valve or on the PC Board using a voltmeter.

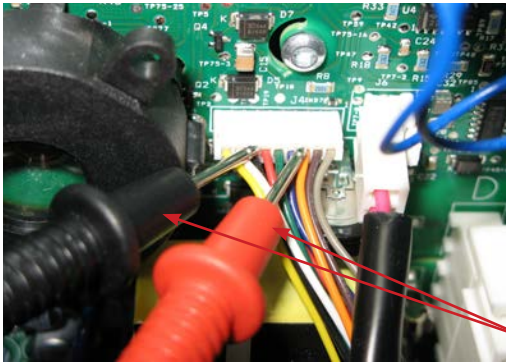

Voltmeter Leads

### Testing Valve Voltage at PC Board

Below are the valve voltage test positions and voltages that should be present at each one:

**NOTE**– The 1-3 Volt reading will go on and off as the valve cycles. 525 Series have a fixed cycle time of 3.6 seconds @5 LPM. However, when the concentrator goes into its “turn-down” mode, the cycle time is shortened.

Negative Lead	Positive Lead	Voltage Reading
Orange	Yellow or White	12 VDC
Orange	Gray	5 VDC
Orange	Brown	5 VDC (intermittent)
Black or Green or Red or Blue	Yellow or White	1-3 VDC (intermittent)

- a. If any of these readings are not obtained, check for loose or broken wires in the harness. If wire harness is okay, replace the PC board.
- b. If proper voltages are obtained, replace valve.

### To replace the rotary valve:

1. Make sure the unit is unplugged from the wall outlet.
2. Use the Cabinet Removal instructions listed previously to open the unit.
3. Unplug valve wire harness from the valve.
4. Loosen clamps and remove bed hoses from each side of valve.
5. Loosen ladder clamps and remove pressure intake and exhaust hoses from backside of valve, then remove valve.
6. Install the new rotary valve by reversing the above procedure.

# FIGURES, DIAGRAMS AND PARTS LIST

**525DS Unit - Serial # "F" (115V Units)**  
**525DS & 525DS-Q Units - Serial # "J" (115V Units)**

Front View

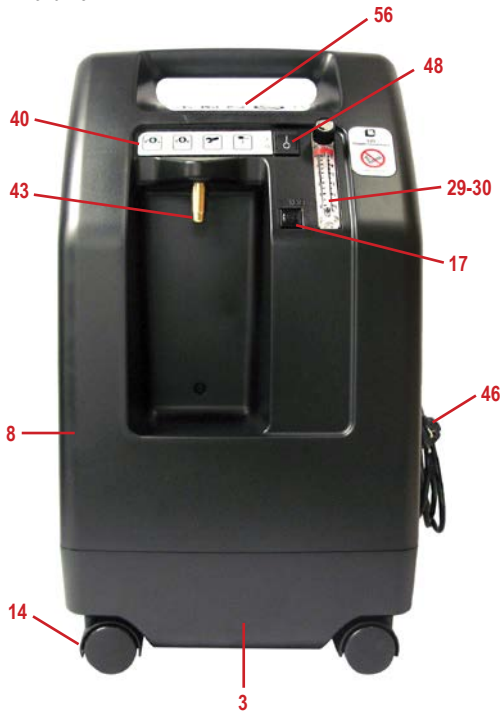

Rear View

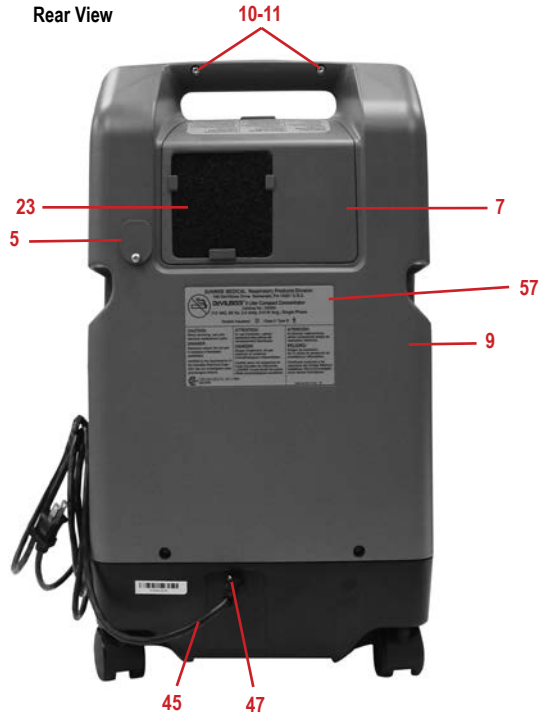

Front Inside

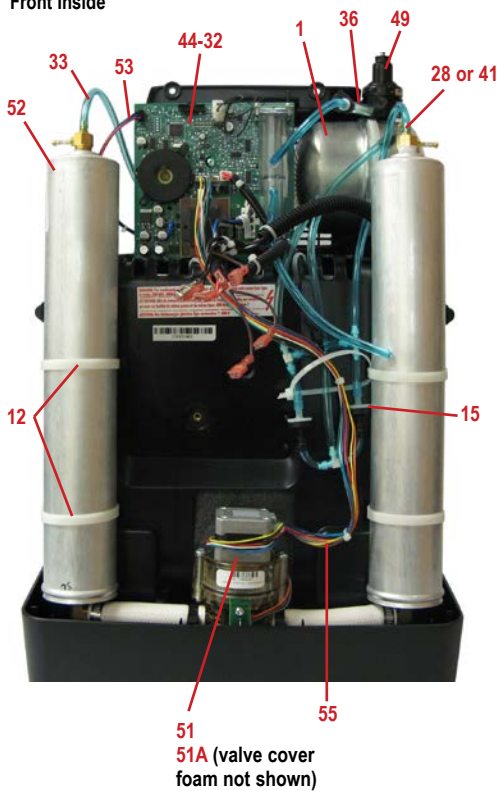

Rear Inside

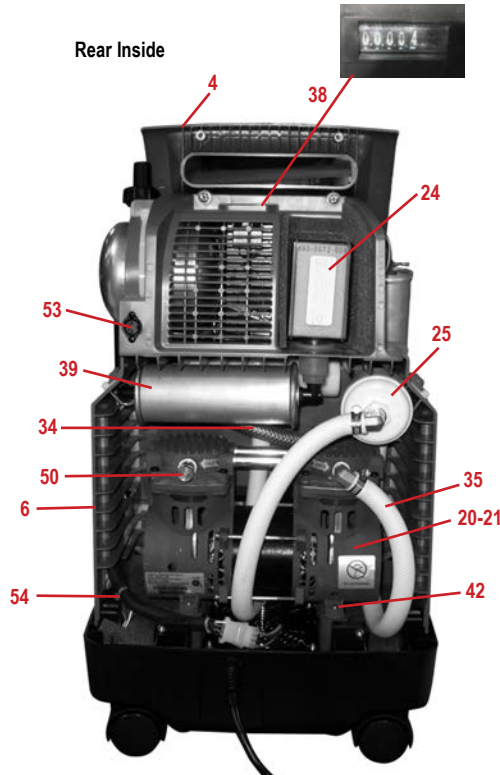

Behind Front Cover/Bib

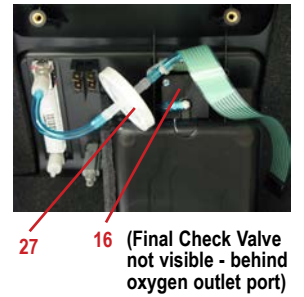

Fan & Capacitor

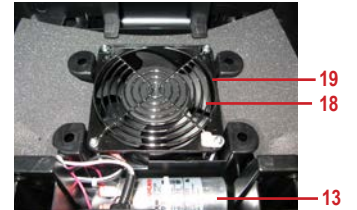

Compressor Box



# FIGURES, DIAGRAMS AND PARTS LIST

## 525DS Unit - Serial # "F" (115V Units) 525DS & 525DS-Q Units - Serial # "J" (115V Units)

	PART DESCRIPTION	525DS "F" SERIAL #	525DS "J" SERIAL #	525DS-Q "J" SERIAL #
1	Accumulator Tank	525D-610	525D-610	525D-610
2	Auxiliary Oxygen Port	N/A	N/A	N/A
<b>Cabinet Parts:</b>				
3	Base	N/A	525DD-603	525DD-603
4	Bib	N/A	N/A	N/A
5	Communication Port Door	N/A	525DD-640	525DD-640
6	Compressor Box	N/A	525DD-605	525DD-605
7	Filter Door	N/A	525DD-639	525DD-639
8	Front Cover	N/A	525DD-611	525DD-611
9	Rear Cover	N/A	525DD-602	525DD-602
10	Cabinet Screw (Machine)	525DD-628	525DD-628	525DD-628
11	Cabinet Screw (Thread-forming)	525DD-636	525DD-636	525DD-636
12	Cable Tie, (Sieve Bed)	505DZ-617	505DZ-617	505DZ-617
13	Capacitor (Motor Start/Run)	525D-616	525D-616	525D-616
14	Caster, Non-locking	501DZ-603	501DZ-603	501DZ-603
<b>Check Valves:</b>				
15	Bed Check Valve	PVO2D-607	PVO2D-607	PVO2D-607
16	Final Check Valve	PVO2D-607	PVO2D-607	PVO2D-607
17	Circuit Breaker	525D-613	525D-613	525D-613
18	Cooling Fan	525DD-634	525DD-634	525DD-634
19	Cooling Fan Guard	N/A	N/A	N/A
20	Compressor	525D-625	525D-625	525D-625
21	Compressor Rebuild Kit	525D-643	525D-643	525D-643
22	Exhaust Muffler	515A-705	515A-705	515A-705
<b>Filters:</b>				
23	Cabinet Air Filter	303DZ-605	303DZ-605	303DZ-605
24	Intake Bacteria Filter	MC44D-605	MC44D-605	MC44D-605
25	Compressor Filter (Plastic) - Obsolete	Order 525DD-626	Order 525DD-626	Order 525DD-626
26	Compressor Filter (Sintered Bronze)	N/A	N/A	N/A
27	Final Bacteria Filter	PV5LD-651	PV5LD-651	PV5LD-651
<b>Fittings:</b>				
28	Accumulator Tank "Tee"	444-582	444-582	444-582
<b>Flow Meters:</b>				
29	Standard Flow Meter	505DZ-607	505DZ-607	505DZ-607
30	Low Output Meter	515LF-607	515LF-607	515LF-607
31	Foam Kit	525D-600	N/A	N/A
32	Fuse (For PC Board)	N/A	N/A	N/A
<b>Hoses:</b>				
33	1/8" ID (Blue) (4' Lg)	444-554	444-554	444-554
34	1/2" ID PVC Braided (4' Lg)	444-549	444-549	444-549
35	1/2" ID Silicone Braided (2' Lg)	505DZ-634	505DZ-634	505DZ-634
<b>Hose Clamps:</b>				
36	Plastic (1/4" ID Hose)	N/A	N/A	N/A
37	Ladder Clamp (1/2" ID Hoses)	444-566	444-566	444-566
38	Hour Meter	PV5LD-617	PV5LD-617	PV5LD-617
39	Intake Canister	525DD-614	525DD-614	525DD-614
40	Light Panel / Ribbon Cable	525D-615	525DS-615	525DS-615
41	Purge Manifold Assembly	N/A	525DD-617	525DD-617
42	Motor Mounts	505IZ-609	505IZ-609	505IZ-609
43	Oxygen Outlet Port	525DD-606	525DD-606	525DD-606
44	PC Board	525DS-622	525DS-622	525DS-622
45	Power Cord w/Strain Relief	PV5LD-618	PV5LD-618	PV5LD-618
46	Power Cord Strap	MC29D-657	MC29D-657	MC29D-657
47	Power Cord Strain Relief	505DZ-645	505DZ-645	505DZ-645
48	Power Switch	505DZ-508	505DZ-508	505DZ-508
49	Pressure Regulator	MC29D-612	MC29D-612	MC29D-612
50	Pressure Relief Valve	515ADZ-614	515ADZ-614	515ADZ-614
51	Rotary Valve	515ADZ-702	515ADZ-702	515ADZ-702
51A	Valve Cover Foam	525DD-642	525DD-642	525DD-642
52	Sieve Bed	525D-619	525D-619	525D-619
<b>Wire Harness:</b>				
53	Communication Harness/Port	525D-608	525D-608	525D-608
54	Main Harness	515DZ-623	515DZ-623	515DZ-623
55	Rotary Valve Harness	525D-621	525D-621	525D-621
56	Top Label	N/A	N/A	N/A
57	Rating Label	N/A	N/A	N/A

# FIGURES, DIAGRAMS AND PARTS LIST

**525DS Unit - Serial # "N" (115V Units with Auxiliary Oxygen Port)**  
**525DS-Q Unit - Serial # "R" (115V Units with Auxiliary Oxygen Port)**

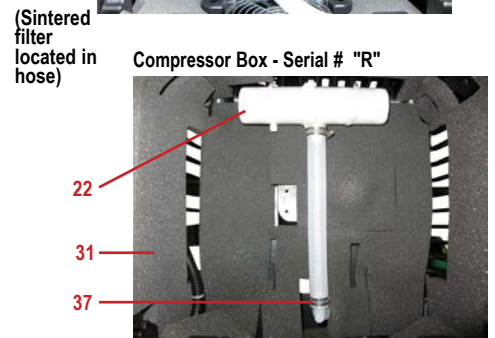
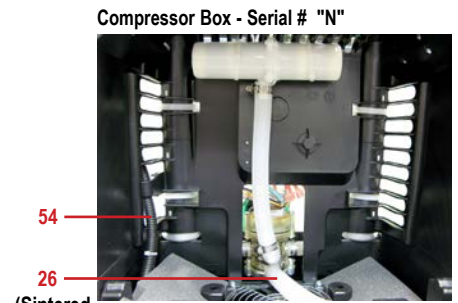
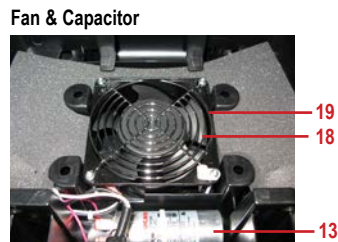
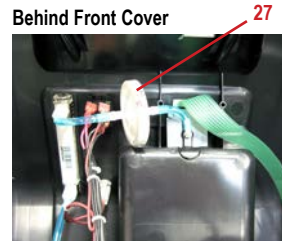
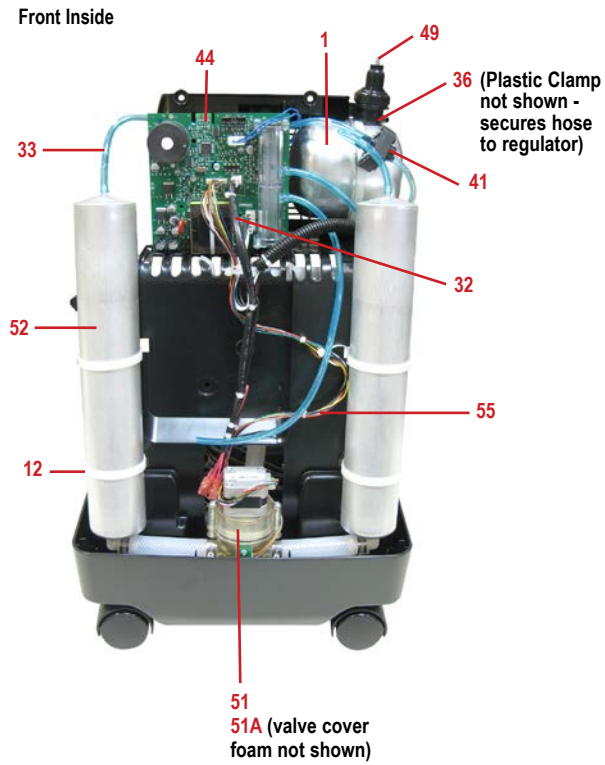

# FIGURES, DIAGRAMS AND PARTS LIST

## 525DS Unit - Serial # "N" (115V Units with Auxiliary Oxygen Port) 525DS-Q Unit - Serial # "R" (115V Units with Auxiliary Oxygen Port)

Rear Inside - Serial # "N"

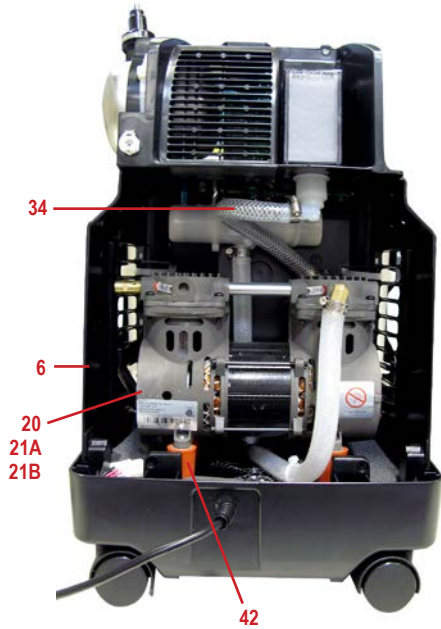

Rear Inside - Serial # "R"

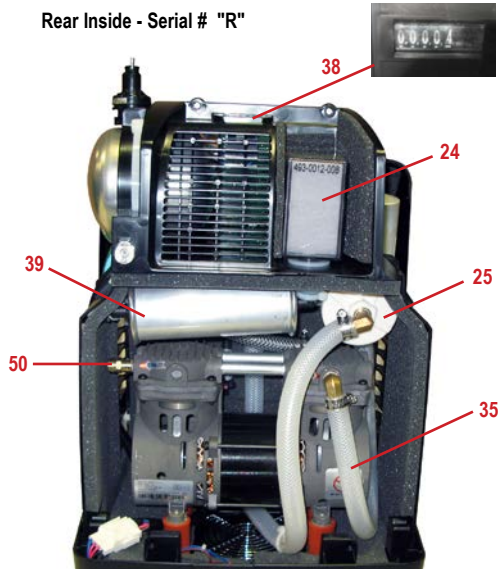

	PART DESCRIPTION	525DS "N" SERIAL #	525DS-Q "R" SERIAL #
1	Accumulator Tank	525D-610	525D-610
2	Auxiliary Oxygen Port	525DD-635	525DD-635
<b>Cabinet Parts:</b>			
3	Base	525DD-603	525DD-603
4	Bib	N/A	N/A
5	Communication Port Door	N/A	N/A
6	Compressor Box	525DD-615	525DD-615
7	Filter Door	525DD-639	525DD-639
8	Front Cover	525DD-611	525DD-611
9	Rear Cover	525DD-612	525DD-612
10	Cabinet Screw (Machine)	525DD-628	525DD-628
11	Cabinet Screw (Thread-forming)	525DD-636	525DD-636
12	Cable Tie, (Sieve Bed)	505DZ-617	505DZ-617
13	Capacitor (Motor Start/Run)	525D-616	525D-616
14	Caster, Non-locking	501DZ-603	501DZ-603
<b>Check Valves:</b>			
15	Bed Check Valve	N/A	N/A
16	Final Check Valve	N/A	N/A
17	Circuit Breaker	525D-613	525D-613
18	Cooling Fan	525DD-634	525DD-634
19	Cooling Fan Guard	N/A	N/A
20	Compressor (GSE / Thomas)	525D-625	525D-625
21A	Compressor Rebuild Kit (GSE)	525D-643	525D-643
21B	Compressor Rebuild Kit (Thomas)	525D-653	525D-653
22	Exhaust Muffler	515A-705	515A-705
<b>Filters:</b>			
23	Cabinet Air Filter	303DZ-605	303DZ-605
24	Intake Bacteria Filter	MC44D-605	MC44D-605
25	Compressor Filter (Plastic) - Obsolete	Order 525DD-626	Order 525DD-626
26	Compressor Filter (Sintered Bronze)	525DD-626	525DD-626
27	Final Bacteria Filter	PV5LD-651	PV5LD-651
<b>Fittings:</b>			
28	Accumulator Tank "Tee"	N/A	N/A

# FIGURES, DIAGRAMS AND PARTS LIST

## 525DS Unit - Serial # "N" (115V Units with Auxiliary Oxygen Port)

## 525DS-Q Unit - Serial # "R" (115V Units with Auxiliary Oxygen Port)

	PART DESCRIPTION	525DS "N" SERIAL #	525DS-Q "R" SERIAL #
	<b>Flow Meters:</b>		
29	Standard Flow Meter	505DZ-607	505DZ-607
30	Low Output Meter	515LF-607	515LF-607
31	Foam Kit	N/A	N/A
32	Fuse (For PC Board)	N/A	N/A
	<b>Hoses:</b>		
33	1/8" ID (Blue) (4' Lg)	444-554	444-554
34	1/2" ID PVC Braided (4' Lg)	444-549	444-549
35	1/2" ID Silicone Braided (2' Lg)	505DZ-634	505DZ-634
	<b>Hose Clamps:</b>		
36	Plastic (1/4" ID Hose)	N/A	N/A
37	Ladder Clamp (1/2" ID Hoses)	444-566	444-566
38	Hour Meter	PV5LD-617	PV5LD-617
39	Intake Canister	N/A	525DD-614
40	Light Panel / Ribbon Cable	525DS-615	525DD-615
41	Purge Manifold Assembly	525DD-617	525DD-617
42	Motor Mounts	505IZ-609	505IZ-609
43	Oxygen Outlet Port	525DD-606	525DD-606
44	PC Board	525DD-622	525DD-622
45	Power Cord w/Strain Relief	PV5LD-618	PV5LD-618
46	Power Cord Strap	MC29D-657	MC29D-657
47	Power Cord Strain Relief	505DZ-645	505DZ-645
48	Power Switch	505DZ-508	505DZ-508
49	Pressure Regulator	MC29D-612	MC29D-612
50	Pressure Relief Valve (for GSE compressor)	515ADZ-614	515ADZ-614
51	Rotary Valve	515ADZ-702	515ADZ-702
51A	Valve Cover Foam	525DD-642	525DD-642
52	Sieve Bed	525D-619	525D-619
	<b>Wire Harness:</b>		
53	Communication Harness/Port	N/A	N/A
54	Main Harness	525DD-623	525DD-623
55	Rotary Valve Harness	525D-621	525D-621
56	Top Label	525DD-641	525DD-641
57	Rating Label	525DD-633	525DQ-633

# FIGURES, DIAGRAMS AND PARTS LIST

## 525DS Unit - Serial # "B" (115V Units with Auxiliary Oxygen Port) 525DS-Q Unit - Serial # "B" (115V Units with Auxiliary Oxygen Port)

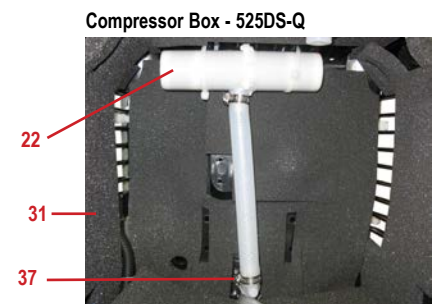
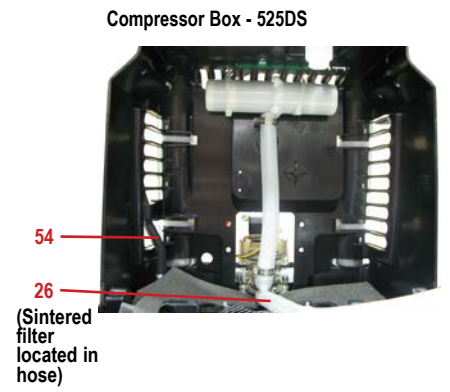
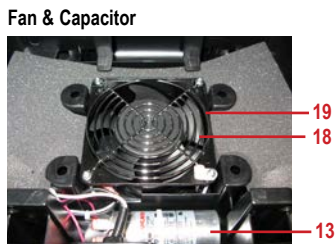
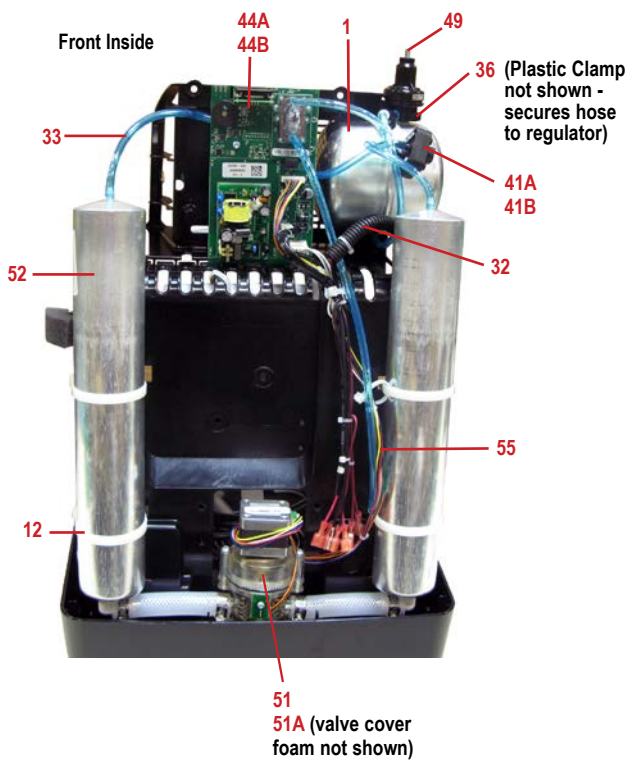

# FIGURES, DIAGRAMS AND PARTS LIST

## 525DS Unit - Serial # "B" (115V Units with Auxiliary Oxygen Port) 525DS-Q Unit - Serial # "B" (115V Units with Auxiliary Oxygen Port)

Rear Inside - 525DS

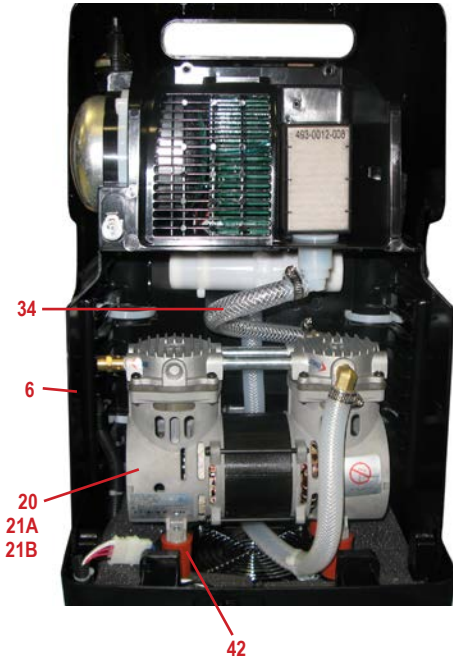

Auxiliary O<sub>2</sub> Port Tubing w/Orifice

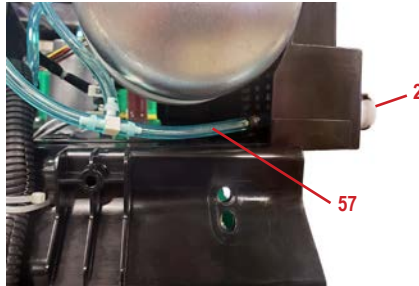

Rear Inside - 525DS-Q

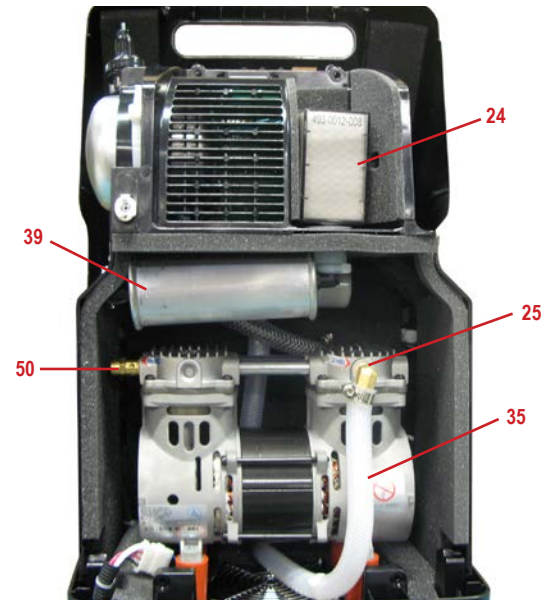

	PART DESCRIPTION	525DS "B" SERIAL #	525DS-Q "B" SERIAL #
1	Accumulator Tank	525D-610	525D-610
2	Auxiliary Oxygen Port	525DD-635	525DD-635
<b>Cabinet Parts:</b>			
3	Base	525DD-603	525DD-603
4	Bib	N/A	N/A
5	Communication Port Door	N/A	N/A
6	Compressor Box	525DD-625	525DD-625
7	Filter Door	525DD-639	525DD-639
8	Front Cover	525DD-611	525DD-611
9	Rear Cover	525DD-612	525DD-612
10	Cabinet Screw (Machine)	525DD-628	525DD-628
11	Cabinet Screw (Thread-forming)	525DD-636	525DD-636
12	Cable Tie (Sieve Bed)	505DZ-617	505DZ-617
13	Capacitor (Motor Start/Run)	525D-616	525D-616
14	Caster, Non-locking	501DZ-603	501DZ-603
<b>Check Valves:</b>			
15	Bed Check Valve	N/A	N/A
16	Final Check Valve	N/A	N/A
17	Circuit Breaker	525D-613	525D-613
18	Cooling Fan	525DD-634	525DD-634
19	Cooling Fan Guard	N/A	N/A
20	Compressor (GSE / Thomas)	525D-625	525D-625
21A	Compressor Rebuild Kit (GSE)	525D-643	525D-643
21B	Compressor Rebuild Kit (Thomas)	525D-653	525D-653
22	Exhaust Muffler	515A-705	515A-705
<b>Filters:</b>			
23	Cabinet Air Filter	303DZ-605	303DZ-605
24	Intake Bacteria Filter	MC44D-605	MC44D-605
25	Compressor Filter (Plastic)	N/A	N/A
26	Compressor Filter (Sintered Bronze)	525DD-626	525DD-626
27	Final Bacteria Filter	PV5LD-651	PV5LD-651
<b>Fittings:</b>			
28	Accumulator Tank "Tee"	N/A	N/A

## FIGURES, DIAGRAMS AND PARTS LIST

### 525DS Unit - Serial # "B" (115V Units with Auxiliary Oxygen Port)

### 525DS-Q Unit - Serial # "B" (115V Units with Auxiliary Oxygen Port)

	PART DESCRIPTION	525DS "B" SERIAL #	525DS-Q "B" SERIAL #
	<b>Flow Meters:</b>		
29	Standard Flow Meter	505DZ-607	505DZ-607
30	Low Output Meter	515LF-607	515LF-607
31	Foam Kit	N/A	N/A
32	Fuse (For PC Board)	N/A	N/A
	<b>Hoses:</b>		
33	1/8" ID (Blue) (4' Lg)	444-554	444-554
34	1/2" ID PVC Braided (4' Lg)	444-549	444-549
35	1/2" ID Silicone Braided (2' Lg)	505DZ-634	505DZ-634
	<b>Hose Clamps:</b>		
36	Plastic (1/4" ID Hose)	N/A	N/A
37	Ladder Clamp (1/2" ID Hoses)	444-566	444-566
38	Hour Meter	N/A	N/A
39	Intake Canister	N/A	525DD-614
40	Front Label	525DD-627	525DD-627
41A	Purge Manifold (black)	525DD-617	525DD-617
41B	Purge Manifold (black & white - low pressure units only)	525DD-618	525DD-618
42	Motor Mounts	505IZ-609	505IZ-609
43	Oxygen Outlet Port	525DD-606	525DD-606
44A	PC Board	525DD-632	525DD-632
44B	PC Board (low pressure system units only)	525DD-638	525DD-638
45	Power Cord w/Strain Relief	PV5LD-618	PV5LD-618
46	Power Cord Strap	MC29D-657	MC29D-657
47	Power Cord Strain Relief	505DZ-645	505DZ-645
48	Power Switch	505DZ-508	505DZ-508
49	Pressure Regulator	MC29D-612	MC29D-612
50	Pressure Relief Valve (for GSE compressor)	515ADZ-614	515ADZ-614
51	Rotary Valve	515ADZ-702	515ADZ-702
51A	Valve Cover Foam	525DD-642	525DD-642
52	Sieve Bed	525D-619	525D-619
	<b>Wire Harness:</b>		
53	Communication Harness/Port	N/A	N/A
54	Main Harness	525DD-623	525DD-623
55	Rotary Valve Harness	525D-621	525D-621
56	Top Label	525DD-631	525DD-631
57	Auxiliary O <sub>2</sub> Port Tubing w/Orifice	525DD-645	525DD-645
58	Rating Label	525DD-633	525DQ-633

# FIGURES, DIAGRAMS AND PARTS LIST

**525KS Unit - Serial # "F" (220/230/240V Units)**  
**525KS & 525KS-LT Units - Serial # "J" (220/230/240V Units)**

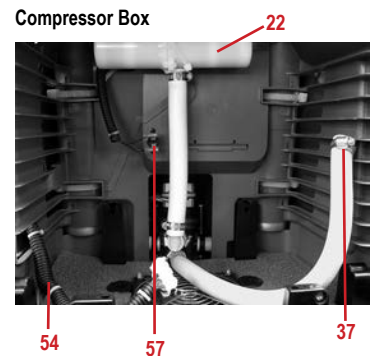
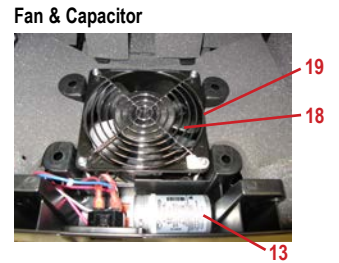
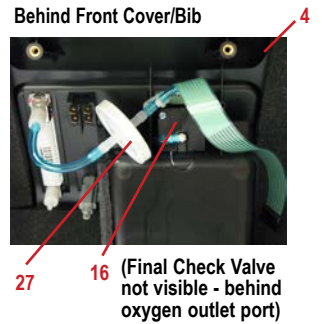
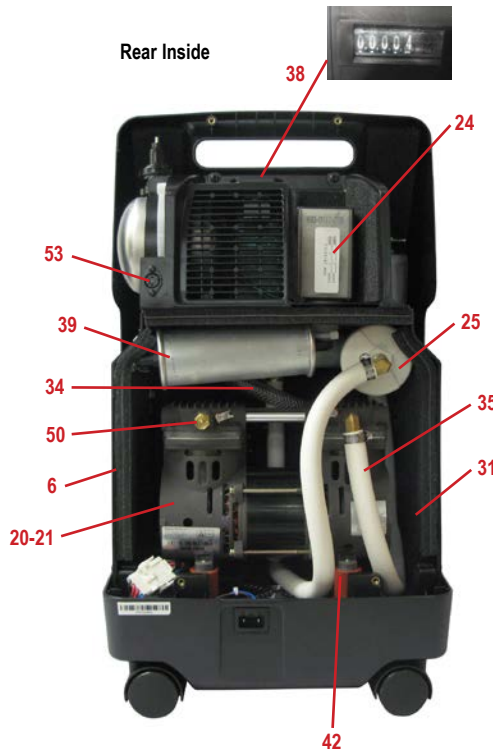
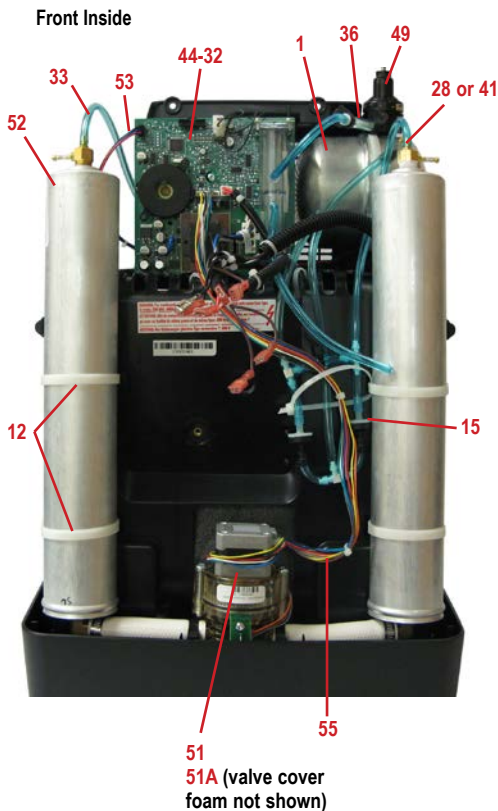
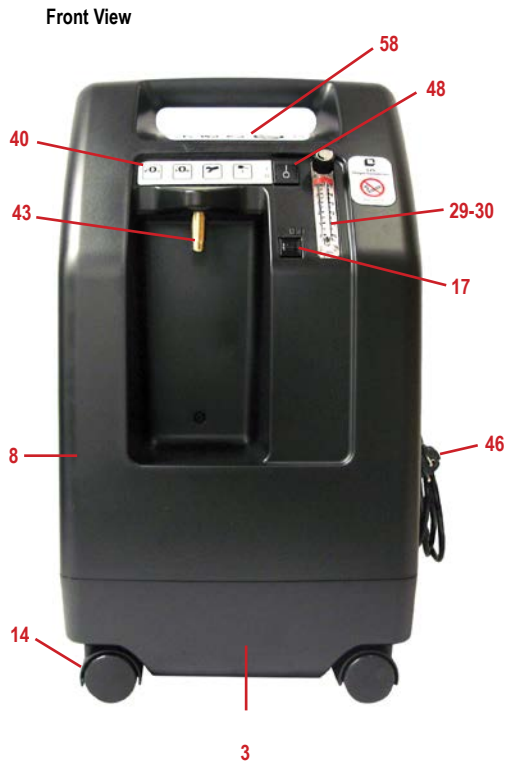

# FIGURES, DIAGRAMS AND PARTS LIST

## 525KS Unit - Serial # "F" (220/230/240V Units)

## 525KS & 525KS-LT Units - Serial # "J" (220/230/240V Units)

	PART DESCRIPTION	525KS "F" SERIAL #	525KS "J" SERIAL #	525KS-LT "J" SERIAL #
1	Accumulator Tank	525D-610	525D-610	525D-610
2	Auxiliary Oxygen Port	N/A	N/A	N/A
<b>Cabinet Parts:</b>				
3	Base	N/A	525KD-603	525KD-603
4	Bib	N/A	N/A	N/A
5	Communication Port Door	N/A	525DD-640	525DD-640
6	Compressor Box	N/A	525DD-605	525DD-605
7	Filter Door	N/A	525DD-639	525DD-639
8	Front Cover	N/A	525DD-611	525DD-611
9	Rear Cover	N/A	525DD-602	525DD-602
10	Cabinet Screw (Machine)	525DD-628	525DD-628	525DD-628
11	Cabinet Screw (Thread-forming)	525DD-636	525DD-636	525DD-636
12	Cable Tie, (Sieve Bed)	505DZ-617	505DZ-617	505DZ-617
13	Capacitor (Motor Start/Run)	525K-616	525K-616	525K-616
14	Caster, Non-locking	501DZ-603	501DZ-603	501DZ-603
<b>Check Valves:</b>				
15	Bed Check Valve	PVO2D-607	PVO2D-607	PVO2D-607
16	Final Check Valve	PVO2D-607	PVO2D-607	PVO2D-607
17	Circuit Breaker	515KZ-615	515KZ-615	515KZ-615
18	Cooling Fan	515UK-634	515UK-634	515UK-634
19	Cooling Fan Guard	N/A	N/A	N/A
20	Compressor	525K-625	525K-625	525K-625
21	Compressor Rebuild Kit	525K-643	525K-643	525K-643
22	Exhaust Muffler	515A-705	515A-705	515A-705
<b>Filters:</b>				
23	Cabinet Air Filter	303DZ-605	303DZ-605	303DZ-605
24	Intake Bacteria Filter	MC44D-605	MC44D-605	MC44D-605
25	Compressor Filter (Plastic) - Obsolete	Order 525DD-626	Order 525DD-626	Order 525DD-626
26	Compressor Filter (Sintered Bronze)	N/A	N/A	N/A
27	Final Bacteria Filter	PV5LD-651	PV5LD-651	PV5LD-651
<b>Fittings:</b>				
28	Accumulator Tank "Tee"	444-582	444-582	444-582
<b>Flow Meters:</b>				
29	Standard Flow Meter	505DZ-607	505DZ-607	505DZ-607
30	Low Output Meter	515LF-607	515LF-607	515LF-607
31	Foam Kit	525D-600	N/A	N/A
32	Fuse (For PC Board)	N/A	N/A	N/A
<b>Hoses:</b>				
33	1/8" ID (Blue) (4' Lg)	444-554	444-554	444-554
34	1/2" ID PVC Braided (4' Lg)	444-549	444-549	444-549
35	1/2" ID Silicone Braided (2' Lg)	505DZ-634	505DZ-634	505DZ-634
<b>Hose Clamps:</b>				
36	Plastic (1/4" ID Hose)	N/A	N/A	N/A
37	Ladder Clamp (1/2" ID Hoses)	444-566	444-566	444-566
38	Hour Meter	PV5LD-617	PV5LD-617	PV5LD-617
39	Intake Canister	525DD-614	525DD-614	525DD-614
40	Light Panel / Ribbon Cable	525D-615	525DS-615	525DS-615
41	Purge Manifold Assembly	N/A	525DD-617	525DD-617
42	Motor Mounts	505IZ-609	505IZ-609	505IZ-609
43	Oxygen Outlet Port	525DD-606	525DD-606	525DD-606
44	PC Board	525KS-622	525KS-622	525KS-622
45	Power Cord w/Strain Relief	VARIOUS	VARIOUS	VARIOUS
46	Power Cord Strap	MC29D-657	MC29D-657	MC29D-657
47	Power Cord Strain Relief	N/A	N/A	N/A
48	Power Switch	505DZ-508	505DZ-508	505DZ-508
49	Pressure Regulator	MC29D-612	MC29D-612	MC29D-612
50	Pressure Relief Valve	515ADZ-614	515ADZ-614	515ADZ-614
51	Rotary Valve	515ADZ-702	515ADZ-702	515ADZ-702
51A	Valve Cover Foam	525DD-642	525DD-642	525DD-642
52	Sieve Bed	525D-619	525D-619	525D-619
<b>Wire Harness:</b>				
53	Communication Harness/Port	525D-608	525D-608	525D-608
54	Main Harness	515AKS-623	515AKS-623	515AKS-623
55	Rotary Valve Harness	525D-621	525D-621	525D-621
56	IEC Connector	N/A	N/A	N/A
57	Thermostat	N/A	N/A	N/A
58	Top Label	N/A	N/A	N/A
59	Rating Label	N/A	N/A	N/A

# FIGURES, DIAGRAMS AND PARTS LIST

**525KS-LT Unit - Serial # "N" (220/230/240V Units with Auxiliary Oxygen Port)**  
**525KS Unit - Serial # "R" (220/230/240V Units with Auxiliary Oxygen Port)**

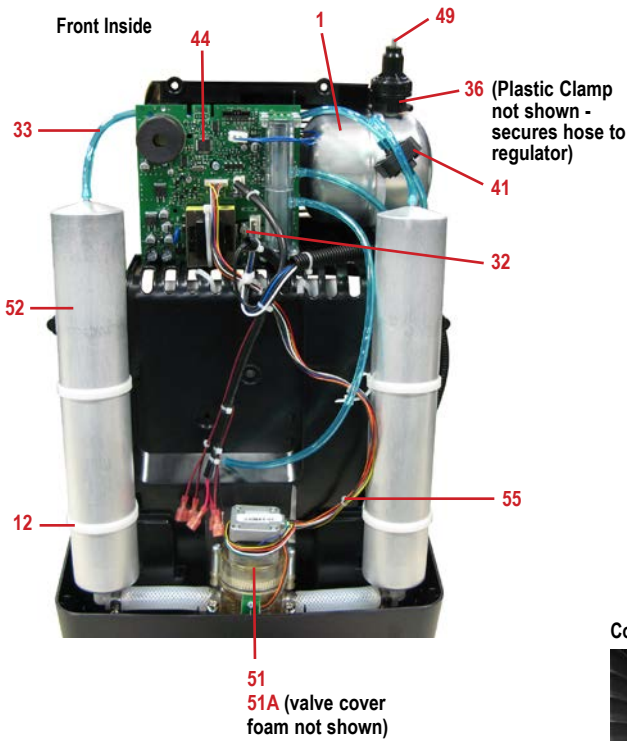

Behind Front Cover

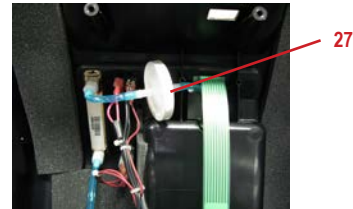

Fan & Capacitor

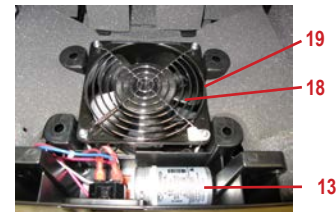

Compressor Box - Serial # "N"



Compressor Box - Serial # "R"

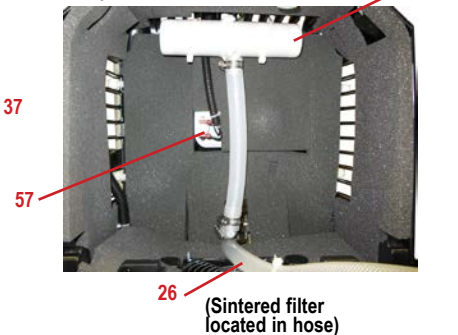

# FIGURES, DIAGRAMS AND PARTS LIST

## 525KS-LT Unit - Serial # "N" (220/230/240V Units with Auxiliary Oxygen Port) 525KS Unit - Serial # "R" (220/230/240V Units with Auxiliary Oxygen Port)

Rear Inside - Serial # "N"

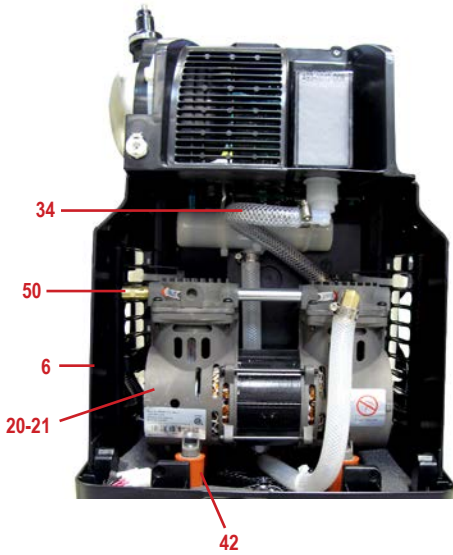

Rear Inside - Serial # "R"

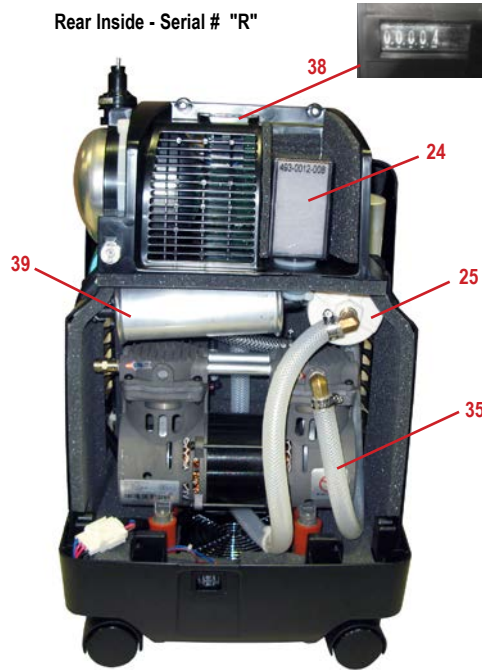

	PART DESCRIPTION	525KS-LT "N" SERIAL #	525KS "R" SERIAL #
1	Accumulator Tank	525D-610	525D-610
2	Auxiliary Oxygen Port	525DD-635	525DD-635
<b>Cabinet Parts:</b>			
3	Base	525KD-603	525KD-603
4	Bib	N/A	N/A
5	Communication Port Door	N/A	N/A
6	Compressor Box	525DD-615	525DD-615
7	Filter Door	525DD-639	525DD-639
8	Front Cover	525DD-611	525DD-611
9	Rear Cover	525DD-612	525DD-612
10	Cabinet Screw (Machine)	525DD-628	525DD-628
11	Cabinet Screw (Thread-forming)	525DD-636	525DD-636
12	Cable Tie, (Sieve Bed)	505DZ-617	505DZ-617
13	Capacitor (Motor Start/Run)	525K-616	525K-616
14	Caster, Non-locking	501DZ-603	501DZ-603
<b>Check Valves:</b>			
15	Bed Check Valve	N/A	N/A
16	Final Check Valve	N/A	N/A
17	Circuit Breaker	515KZ-615	515KZ-615
18	Cooling Fan	515UK-634	515UK-634
19	Cooling Fan Guard	N/A	N/A
20	Compressor	525K-625	525K-625
21	Compressor Rebuild Kit	525K-643	525K-643
22	Exhaust Muffler	515A-705	515A-705
<b>Filters:</b>			
23	Cabinet Air Filter	303DZ-605	303DZ-605
24	Intake Bacteria Filter	MC44D-605	MC44D-605
25	Compressor Filter (Plastic) - Obsolete	Order 525DD-626	Order 525DD-626
26	Compressor Filter (Sintered Bronze)	525DD-626	525DD-626
27	Final Bacteria Filter	PV5LD-651	PV5LD-651

## FIGURES, DIAGRAMS AND PARTS LIST

### 525KS-LT Unit - Serial # "N" (220/230/240V Units with Auxiliary Oxygen Port) 525KS Unit - Serial # "R" (220/230/240V Units with Auxiliary Oxygen Port)

	PART DESCRIPTION	525KS-LT "N" SERIAL #	525KS "R" SERIAL #
	<b>Fittings:</b>		
28	Accumulator Tank "Tee"	N/A	N/A
	<b>Flow Meters:</b>		
29	Standard Flow Meter	505DZ-607	505DZ-607
30	Low Output Meter	515LF-607	515LF-607
31	Foam Kit	N/A	N/A
32	Fuse (For PC Board)	N/A	N/A
	<b>Hoses:</b>		
33	1/8" ID (Blue) (4' Lg)	444-554	444-554
34	1/2" ID PVC Braided (4' Lg)	444-549	444-549
35	1/2" ID Silicone Braided (2' Lg)	505DZ-634	505DZ-634
	<b>Hose Clamps:</b>		
36	Plastic (1/4" ID Hose)	N/A	N/A
37	Ladder Clamp (1/2" ID Hoses)	444-566	444-566
38	Hour Meter	PV5LD-617	PV5LD-617
39	Intake Canister	N/A	525DD-614
40	Light Panel / Ribbon Cable	525DS-615	525DS-615
41	Purge Manifold Assembly	525DD-617	525DD-617
42	Motor Mounts	505IZ-609	505IZ-609
43	Oxygen Outlet Port	525DD-606	525DD-606
44	PC Board	525KD-622	525KD-622
45	Power Cord w/Strain Relief	VARIOUS	VARIOUS
46	Power Cord Strap	MC29D-657	MC29D-657
47	Power Cord Strain Relief	N/A	N/A
48	Power Switch	505DZ-508	505DZ-508
49	Pressure Regulator	MC29D-612	MC29D-612
50	Pressure Relief Valve	515ADZ-614	515ADZ-614
51	Rotary Valve	515ADZ-702	515ADZ-702
51A	Valve Cover Foam	525DD-642	525DD-642
52	Sieve Bed	525D-619	525D-619
	<b>Wire Harness:</b>		
53	Communication Harness/Port	N/A	N/A
54	Main Harness	525KD-623	525KD-623
55	Rotary Valve Harness	525D-621	525D-621
56	IEC Connector	N/A	N/A
57	Thermostat	N/A	N/A
58	Top Label	525DD-641	525DD-641
59	Rating Label	525KLT-633	525KD-633

# FIGURES, DIAGRAMS AND PARTS LIST

**525KS-LT Unit - Serial # "B" (220/230/240V Units with Auxiliary Oxygen Port)**  
**525KS Unit - Serial # "B" (220/230/240V Units with Auxiliary Oxygen Port)**

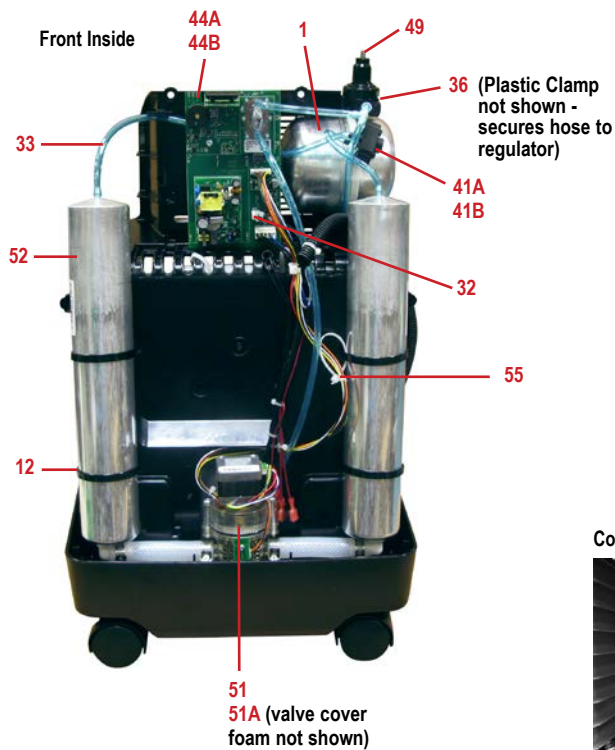
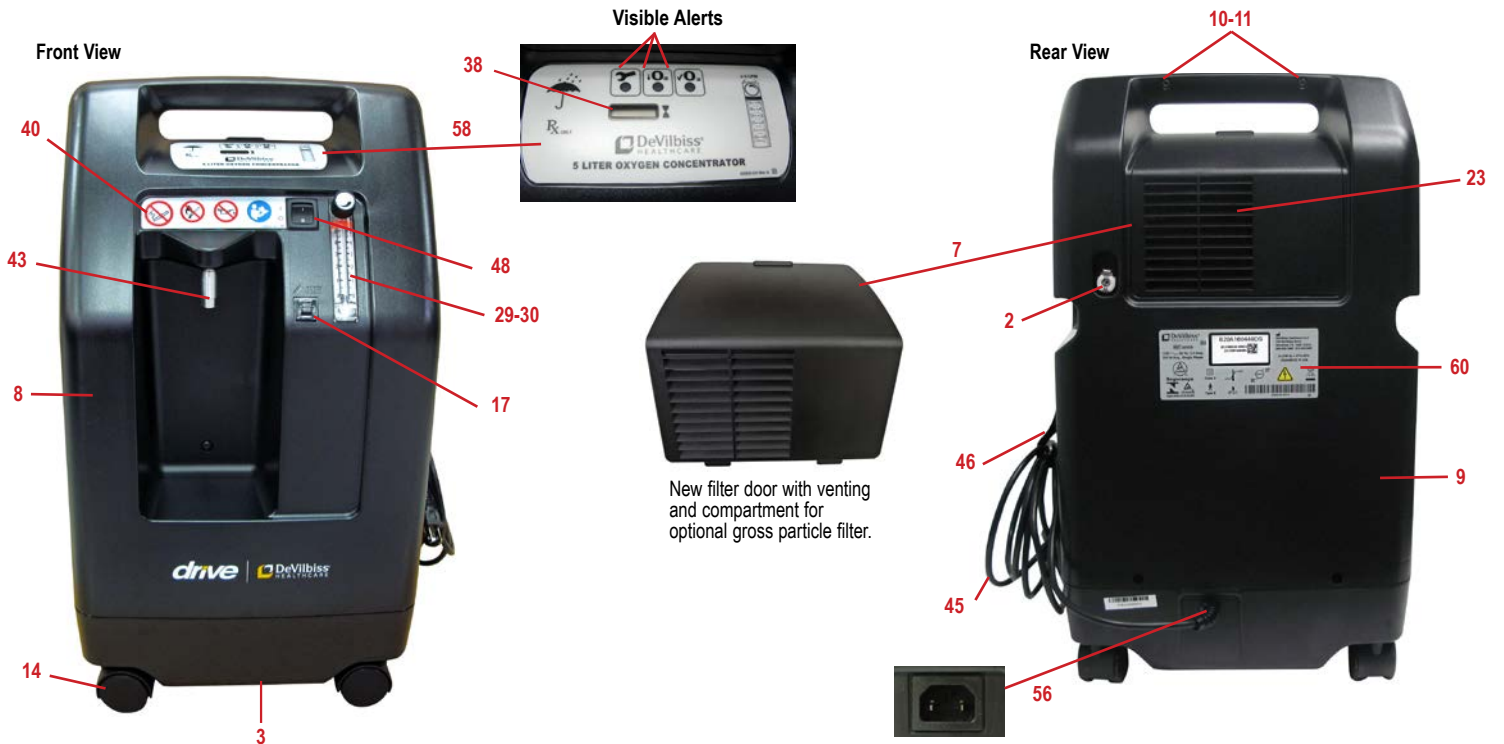

**Behind Front Cover**



**Fan & Capacitor**

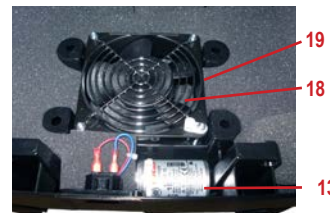

**Compressor Box - 525KS-LT**



**Compressor Box - 525KS**

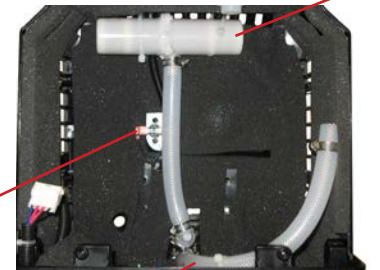

(Sintered filter located in hose)

# FIGURES, DIAGRAMS AND PARTS LIST

## 525KS-LT Unit - Serial # "B" (220/230/240V Units with Auxiliary Oxygen Port) 525KS Unit - Serial # "B" (220/230/240V Units with Auxiliary Oxygen Port)

Rear Inside - 525KS-LT

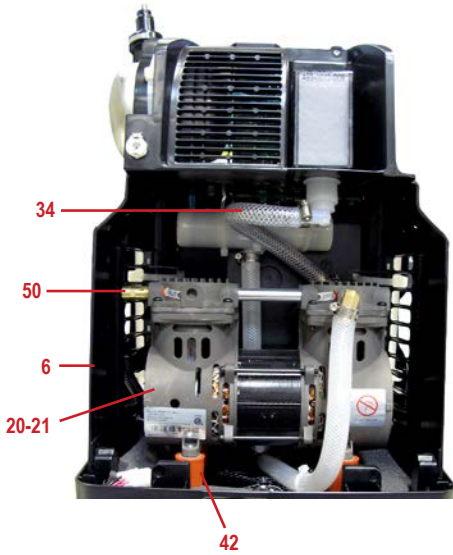

Rear Inside - 525KS

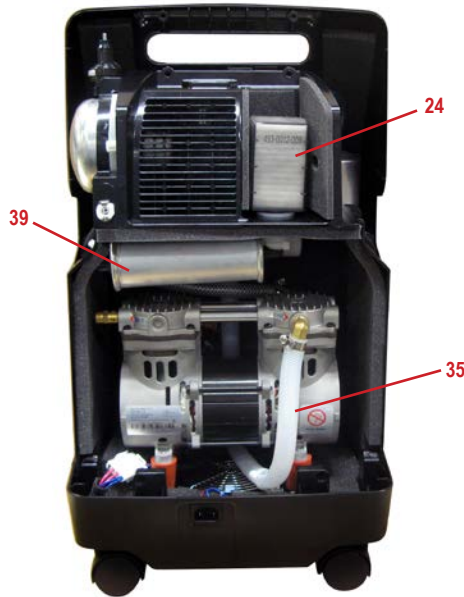

Auxiliary O<sub>2</sub> Port Tubing w/Orifice

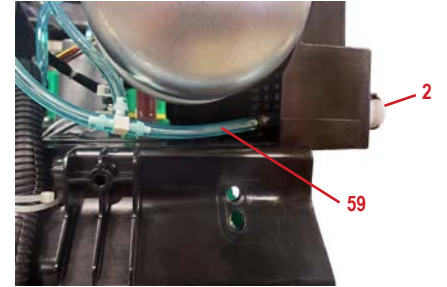

	PART DESCRIPTION	525KS-LT "B" SERIAL #	525KS "B" SERIAL #
1	Accumulator Tank	525D-610	525D-610
2	Auxiliary Oxygen Port	525DD-635	525DD-635
<b>Cabinet Parts:</b>			
3	Base	525KD-603	525KD-603
4	Bib	N/A	N/A
5	Communication Port Door	N/A	N/A
6	Compressor Box	525DD-625	525DD-625
7	Filter Door	525DD-639	525DD-639
8	Front Cover	525DD-611	525DD-611
9	Rear Cover	525DD-612	525DD-612
10	Cabinet Screw (Machine)	525DD-628	525DD-628
11	Cabinet Screw (Thread-forming)	525DD-636	525DD-636
12	Cable Tie, (Sieve Bed)	505DZ-617	505DZ-617
13	Capacitor (Motor Start/Run)	525K-616	525K-616
14	Caster, Non-locking	501DZ-603	501DZ-603
<b>Check Valves:</b>			
15	Bed Check Valve	N/A	N/A
16	Final Check Valve	N/A	N/A
17	Circuit Breaker	515KZ-615	515KZ-615
18	Cooling Fan	515UK-634	515UK-634
19	Cooling Fan Guard	N/A	N/A
20	Compressor	525K-625	525K-625
21	Compressor Rebuild Kit	525K-643	525K-643
22	Exhaust Muffler	515A-705	515A-705
<b>Filters:</b>			
23	Cabinet Air Filter	303DZ-605	303DZ-605
24	Intake Bacteria Filter	MC44D-605	MC44D-605
25	Compressor Filter (Plastic)	N/A	N/A
26	Compressor Filter (Sintered Bronze)	525DD-626	525DD-626
27	Final Bacteria Filter	PV5LD-651	PV5LD-651

## FIGURES, DIAGRAMS AND PARTS LIST

### 525KS-LT Unit - Serial # "B" (220/230/240V Units with Auxiliary Oxygen Port) 525KS Unit - Serial # "B" (220/230/240V Units with Auxiliary Oxygen Port)

	PART DESCRIPTION	525KS-LT "B" SERIAL #	525KS "B" SERIAL #
	<b>Fittings:</b>		
28	Accumulator Tank "Tee"	N/A	N/A
	<b>Flow Meters:</b>		
29	Standard Flow Meter	505DZ-607	505DZ-607
30	Low Output Meter	515LF-607	515LF-607
31	Foam Kit	N/A	N/A
32	Fuse (For PC Board)	N/A	N/A
	<b>Hoses:</b>		
33	1/8" ID (Blue) (4' Lg)	444-554	444-554
34	1/2" ID PVC Braided (4' Lg)	444-549	444-549
35	1/2" ID Silicone Braided (2' Lg)	505DZ-634	505DZ-634
	<b>Hose Clamps:</b>		
36	Plastic (1/4" ID Hose)	N/A	N/A
37	Ladder Clamp (1/2" ID Hoses)	444-566	444-566
38	Hour Meter	N/A	N/A
39	Intake Canister	N/A	525DD-614
40	Front Label	525DD-627	525DD-627
41A	Purge Manifold (black)	525DD-617	525DD-617
41B	Purge Manifold (black & white - low pressure units only)	525DD-618	525DD-618
42	Motor Mounts	505IZ-609	505IZ-609
43	Oxygen Outlet Port	525DD-606	525DD-606
44A	PC Board	525DD-632	525DD-632
44B	PC Board (low pressure system units only)	525DD-638	525DD-638
45	Power Cord w/Strain Relief	VARIOUS	VARIOUS
46	Power Cord Strap	MC29D-657	MC29D-657
47	Power Cord Strain Relief	N/A	N/A
48	Power Switch	505DZ-508	505DZ-508
49	Pressure Regulator	MC29D-612	MC29D-612
50	Pressure Relief Valve	515ADZ-614	515ADZ-614
51	Rotary Valve	515ADZ-702	515ADZ-702
51A	Valve Cover Foam	525DD-642	525DD-642
52	Sieve Bed	525D-619	525D-619
	<b>Wire Harness:</b>		
53	Communication Harness/Port	N/A	N/A
54	Main Harness	525KD-623	525KD-623
55	Rotary Valve Harness	525D-621	525D-621
56	IEC Connector	N/A	N/A
57	Thermostat	N/A	N/A
58	Top Label	525DD-631	525DD-631
59	Auxiliary O <sub>2</sub> Port Tubing w/Orifice	525DD-645	525DD-645
60	Rating Label	525KLT-633	525KD-633

# FIGURES, DIAGRAMS AND PARTS LIST

**525PS Unit - Serial # "F" (220/230/240V Units)**  
**525PS Unit - Serial # "J" (220/230/240V Units)**

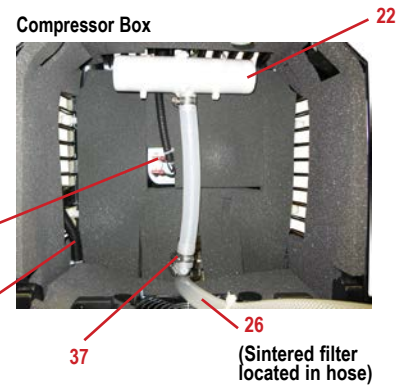
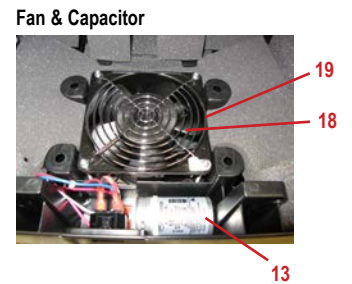
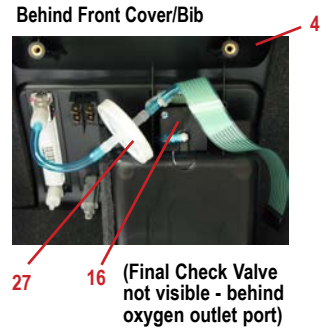
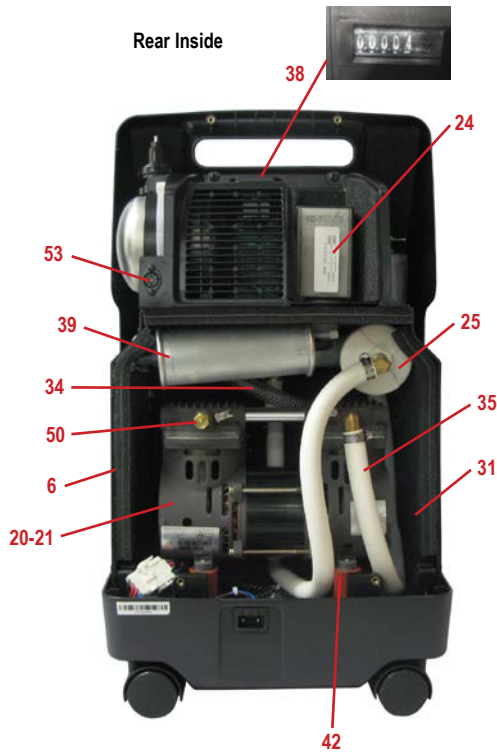
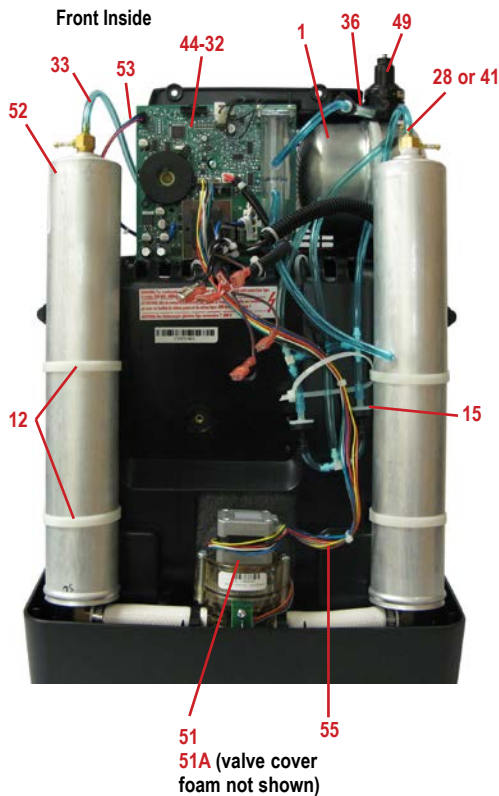
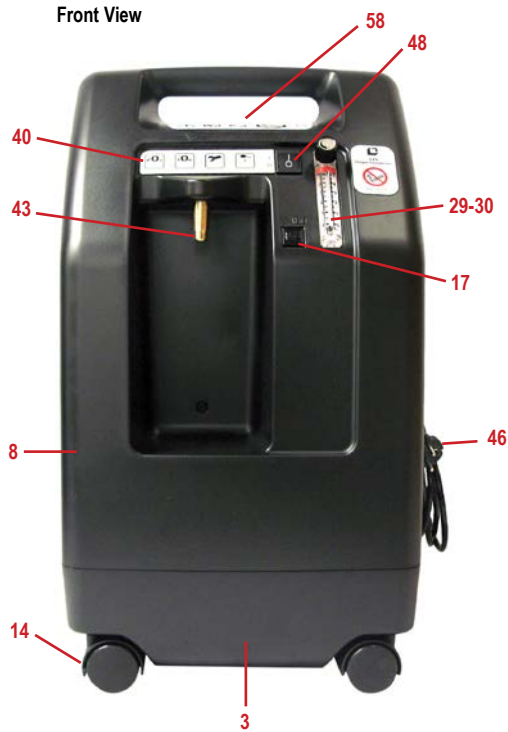

# FIGURES, DIAGRAMS AND PARTS LIST

## 525PS Unit - Serial # "F" (220/230/240V Units)

## 525PS Unit - Serial # "J" (220/230/240V Units)

	PART DESCRIPTION	525PS "F" SERIAL #	525PS "J" SERIAL #
1	Accumulator Tank	525D-610	525D-610
2	Auxiliary Oxygen Port	N/A	N/A
<b>Cabinet Parts:</b>			
3	Base	N/A	525KD-603
4	Bib	N/A	N/A
5	Communication Port Door	N/A	525DD-640
6	Compressor Box	N/A	525DD-605
7	Filter Door	N/A	525DD-639
8	Front Cover	N/A	525DD-611
9	Rear Cover	N/A	525DD-602
10	Cabinet Screw (Machine)	525DD-628	525DD-628
11	Cabinet Screw (Thread-forming)	525DD-636	525DD-636
12	Cable Tie, (Sieve Bed)	505DZ-617	505DZ-617
13	Capacitor (Motor Start/Run)	525K-616	525K-616
14	Caster, Non-locking	501DZ-603	501DZ-603
<b>Check Valves:</b>			
15	Bed Check Valve	PVO2D-607	PVO2D-607
16	Final Check Valve	PVO2D-607	PVO2D-607
17	Circuit Breaker	515KZ-615	515KZ-615
18	Cooling Fan	515UK-634	515UK-634
19	Cooling Fan Guard	N/A	N/A
20	Compressor	525PS-625	525PS-625
21	Compressor Rebuild Kit	525K-643	525K-643
22	Exhaust Muffler	515A-705	515A-705
<b>Filters:</b>			
23	Cabinet Air Filter	303DZ-605	303DZ-605
24	Intake Bacteria Filter	MC44D-605	MC44D-605
25	Compressor Filter (Plastic) - Obsolete	Order 525DD-626	Order 525DD-626
26	Compressor Filter (Sintered Bronze)	N/A	525DD-626
27	Final Bacteria Filter	PV5LD-651	PV5LD-651
<b>Fittings:</b>			
28	Accumulator Tank "Tee"	444-582	444-582
<b>Flow Meters:</b>			
29	Standard Flow Meter	505DZ-607	505DZ-607
30	Low Output Meter	515LF-607	515LF-607
31	Foam Kit	525D-600	N/A
32	Fuse (For PC Board)	N/A	N/A
<b>Hoses:</b>			
33	1/8" ID (Blue) (4' Lg)	444-554	444-554
34	1/2" ID PVC Braided (4' Lg)	444-549	444-549
35	1/2" ID Silicone Braided (2' Lg)	505DZ-634	505DZ-634
<b>Hose Clamps:</b>			
36	Plastic (1/4" ID Hose)	N/A	N/A
37	Ladder Clamp (1/2" ID Hoses)	444-566	444-566
38	Hour Meter	PV5LD-617	PV5LD-617
39	Intake Canister	525DD-614	525DD-614
40	Light Panel / Ribbon Cable	525D-615	525DS-615
41	Purge Manifold Assembly	N/A	525DD-617
42	Motor Mounts	505IZ-609	505IZ-609
43	Oxygen Outlet Port	525DD-606	525DD-606
44	PC Board	525KS-622	525KS-622
45	Power Cord w/Strain Relief	VARIOUS	VARIOUS
46	Power Cord Strap	MC29D-657	MC29D-657
47	Power Cord Strain Relief	N/A	N/A
48	Power Switch	505DZ-508	505DZ-508
49	Pressure Regulator	MC29D-612	MC29D-612
50	Pressure Relief Valve	515ADZ-614	515ADZ-614
51	Rotary Valve	515ADZ-702	515ADZ-702
51A	Valve Cover Foam	525DD-642	525DD-642
52	Sieve Bed	525D-619	525D-619
<b>Wire Harness:</b>			
53	Communication Harness/Port	525D-608	525D-608
54	Main Harness	515AKS-623	515AKS-623
55	Rotary Valve Harness	525D-621	525D-621
56	IEC Connector	N/A	N/A
57	Thermostat	N/A	N/A
58	Top Label	N/A	N/A
59	Rating Label	N/A	N/A

# FIGURES, DIAGRAMS AND PARTS LIST

## 525PS Unit - Serial # "B" (220/230/240V Units with Auxiliary Oxygen Port)

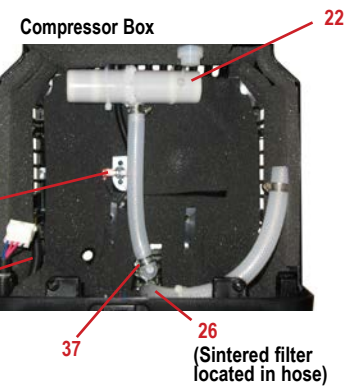
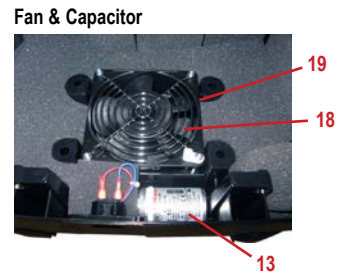
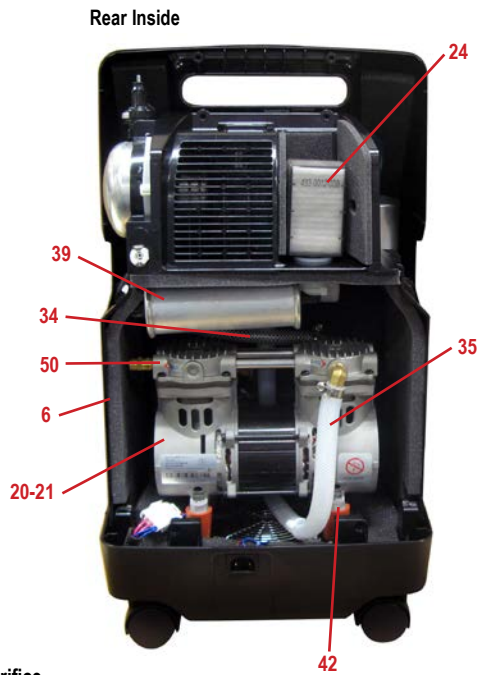
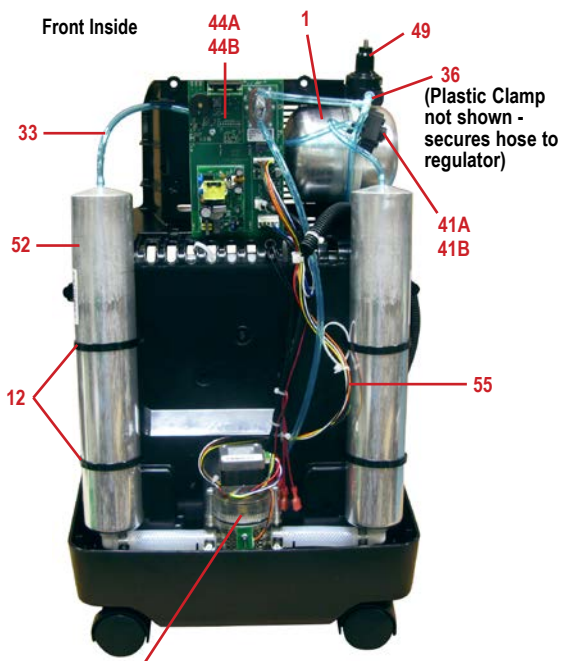
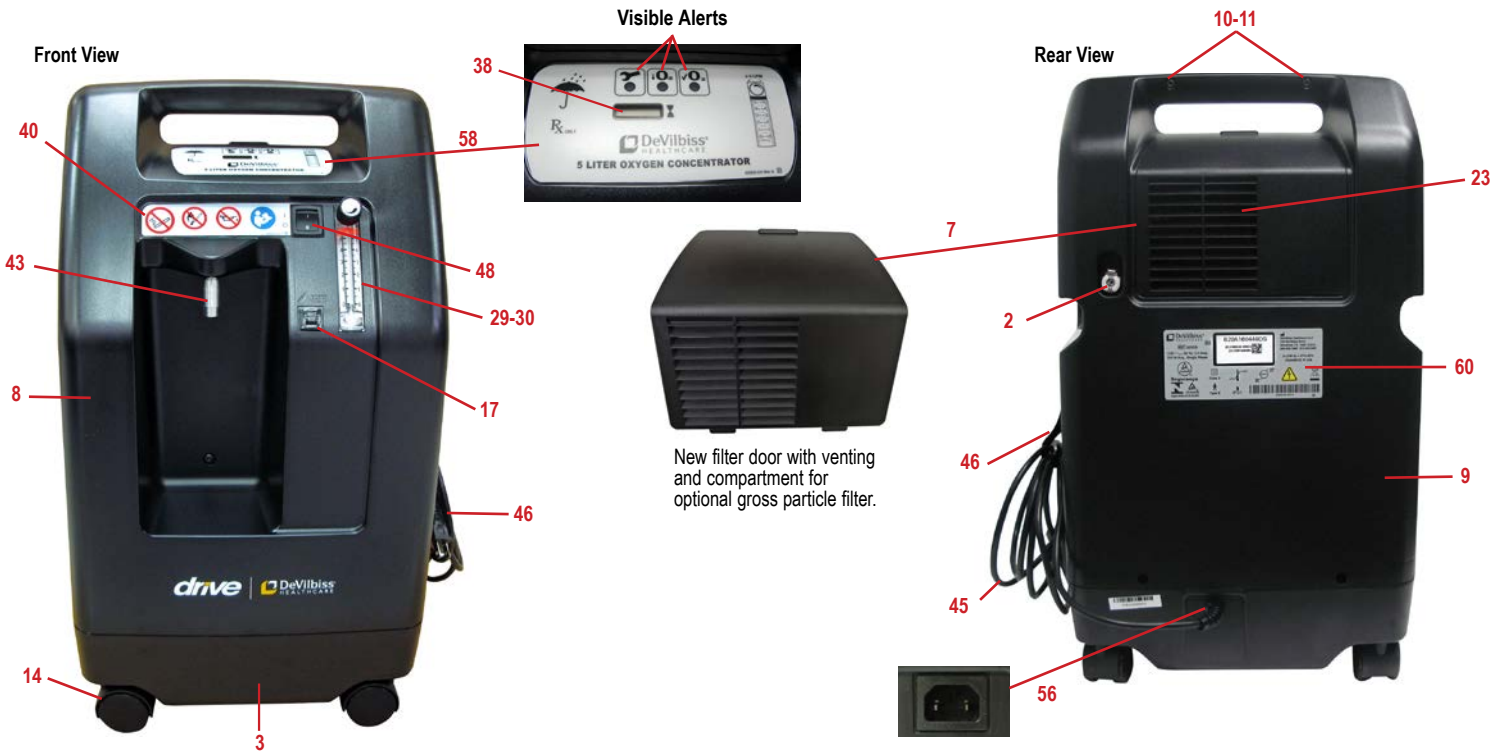

51  
51A (valve cover foam not shown)

**Auxiliary O<sub>2</sub> Port Tubing w/Orifice**

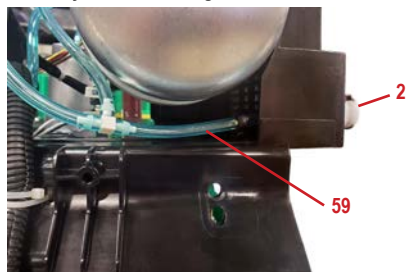

# FIGURES, DIAGRAMS AND PARTS LIST

## 525PS Unit - Serial # "B" (220/230/240V Units with Auxiliary Oxygen Port)

	PART DESCRIPTION	525PS "B" SERIAL #
1	Accumulator Tank	525D-610
2	Auxiliary Oxygen Port	525DD-635
<b>Cabinet Parts:</b>		
3	Base	525KD-603
4	Bib	N/A
5	Communication Port Door	N/A
6	Compressor Box	525DD-625
7	Filter Door	525DD-639
8	Front Cover	525DD-611
9	Rear Cover	525DD-612
10	Cabinet Screw (Machine)	525DD-628
11	Cabinet Screw (Thread-forming)	525DD-636
12	Cable Tie, (Sieve Bed)	505DZ-617
13	Capacitor (Motor Start/Run)	525K-616
14	Caster, Non-locking	501DZ-603
<b>Check Valves:</b>		
15	Bed Check Valve	N/A
16	Final Check Valve	N/A
17	Circuit Breaker	515KZ-615
18	Cooling Fan	515UK-634
19	Cooling Fan Guard	N/A
20	Compressor	525PS-625
21	Compressor Rebuild Kit	525K-643
22	Exhaust Muffler	515A-705
<b>Filters:</b>		
23	Cabinet Air Filter	303DZ-605
24	Intake Bacteria Filter	MC44D-605
25	Compressor Filter (Plastic)	N/A
26	Compressor Filter (Sintered Bronze)	525DD-626
27	Final Bacteria Filter	PV5LD-651
<b>Fittings:</b>		
28	Accumulator Tank "Tee"	N/A
<b>Flow Meters:</b>		
29	Standard Flow Meter	505DZ-607
30	Low Output Meter	515LF-607
31	Foam Kit	N/A
32	Fuse (For PC Board)	N/A
<b>Hoses:</b>		
33	1/8" ID (Blue) (4' Lg)	444-554
34	1/2" ID PVC Braided (4' Lg)	444-549
35	1/2" ID Silicone Braided (2' Lg)	505DZ-634

	PART DESCRIPTION	525PS "B" SERIAL #
<b>Hose Clamps:</b>		
36	Plastic (1/4" ID Hose)	N/A
37	Ladder Clamp (1/2" ID Hoses)	444-566
38	Hour Meter	N/A
39	Intake Canister	525DD-614
40	Front Label	525DD-627
41A	Purge Manifold (black)	525DD-617
41B	Purge Manifold (black & white - low pressure units only)	525DD-618
42	Motor Mounts	505IZ-609
43	Oxygen Outlet Port	525DD-606
44A	PC Board	525DD-632
44B	PC Board (low pressure system units only)	525DD-638
45	Power Cord w/Strain Relief	VARIOUS
46	Power Cord Strap	MC29D-657
47	Power Cord Strain Relief	N/A
48	Power Switch	505DZ-508
49	Pressure Regulator	MC29D-612
50	Pressure Relief Valve	515ADZ-614
51	Rotary Valve	515ADZ-702
51A	Valve Cover Foam	525DD-642
52	Sieve Bed	525D-619
<b>Wire Harness:</b>		
53	Communication Harness/Port	N/A
54	Main Harness	525KD-623
55	Rotary Valve Harness	525D-621
56	IEC Connector	N/A
57	Thermostat	N/A
58	Top Label	525DD-631
59	Auxiliary O <sub>2</sub> Port Tubing w/Orifice	525DD-645
60	Rating Label	525PD-633

## FIGURES, DIAGRAMS AND PARTS LIST

<b>ACCESSORIES</b>	
Carton with Shipping Inserts	525D-606
Oxygen Outlet Connector - Plastic	XM-1
Casters, Locking	525DS-603
Low Output Flow Meter	515LF-607
Transfill Caddy	525DD-650
Transfill Hose	PF1100TUB
<b>TOOLS</b>	
Service Kit	444-501
Pressure Gauge	PVO2D-601
Pressure Test Assembly	303DZ-637
Oxygen Analyzer (Max O <sub>2</sub> )	R217P62
Pressure Test Adapter (1/16" to 1/8")	525DD-637

## Pneumatic Diagram

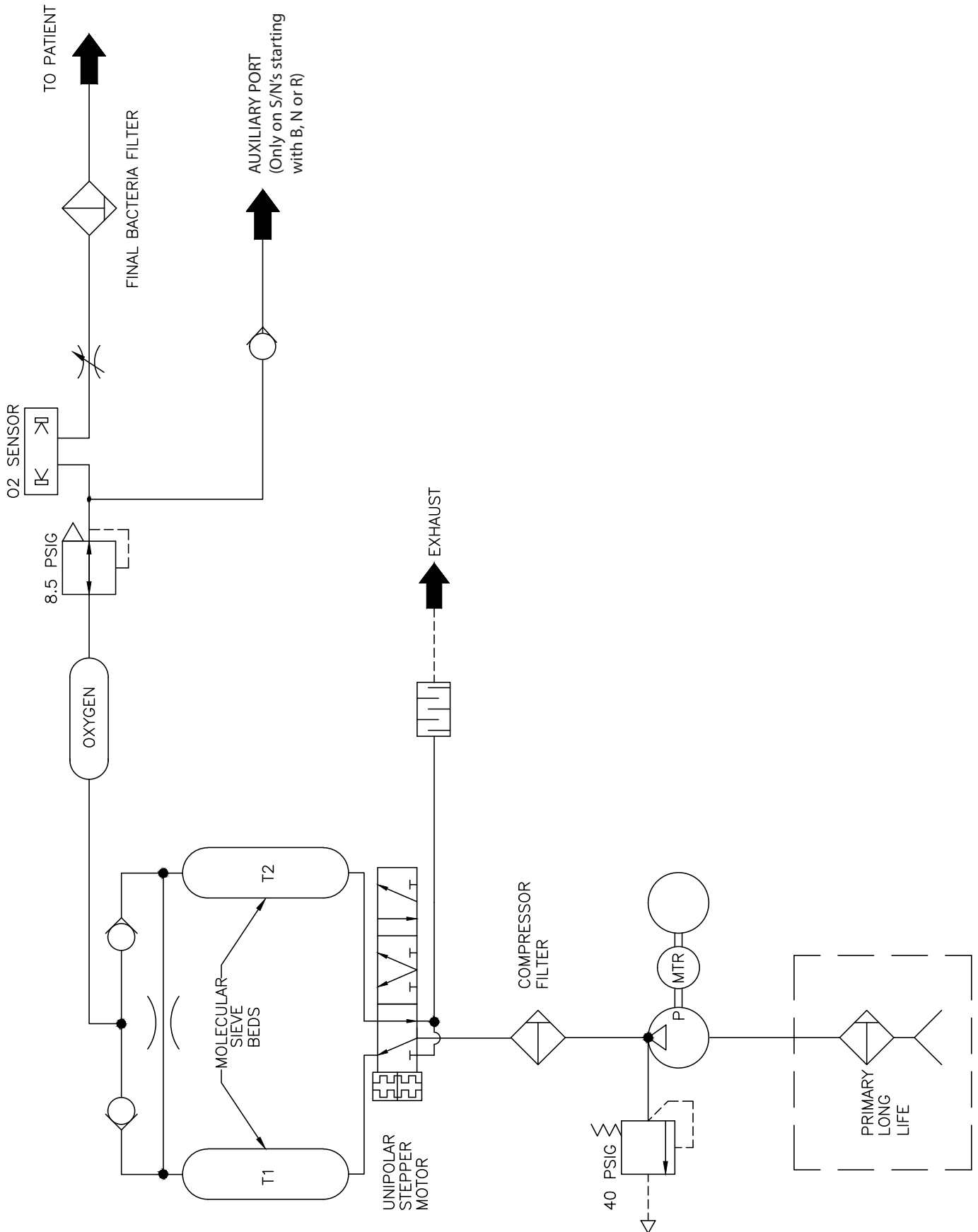

## Wiring Diagram

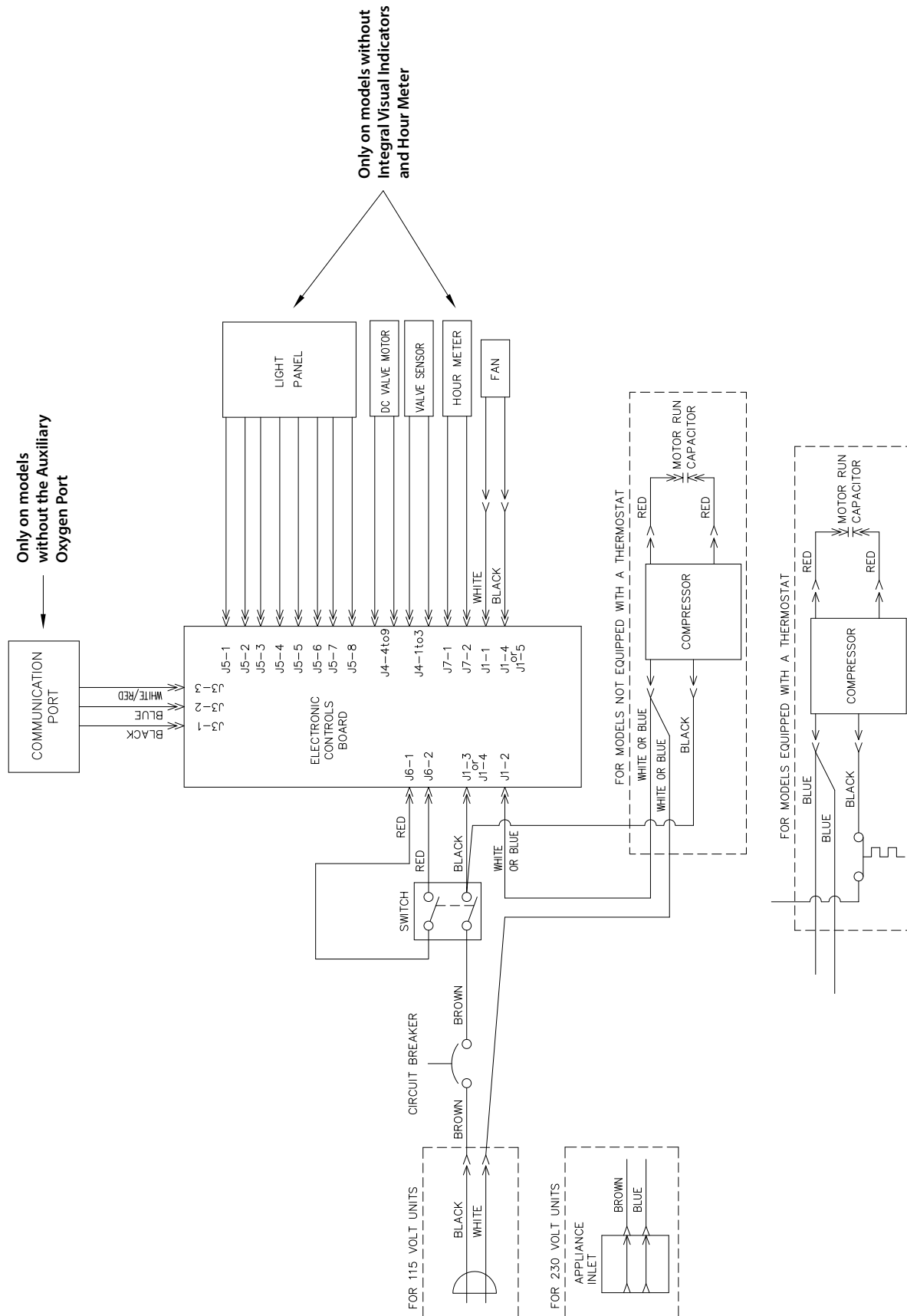

## ORDERING INFORMATION

When ordering components, instruction guides, or service manuals the following must be provided:

- Unit Catalog Number
- Unit Serial Number
- Part Number
- Quantity Required

### DeVilbiss Concentrator 5 Liter Series Instruction Guide:

- A-525D4            525DS                    English, Spanish, French
- SE-525K4        525DS, 525KS, 525PS    English, Spanish, French, German, Italian, Dutch, Portuguese, Polish, Turkish, Arabic
- NE-525K4        525DS, 525KS, 525PS    English, Swedish, Finnish, Danish, Norwegian, Greek
- SE-525K4-SK    525DS, 525KS, 525PS    Slovak, English
- SE-525K4-CS    525DS, 525KS, 525PS    Czech, English
- SE-525K4-ZH    525DS, 525KS, 525PS    Chinese, English
- SE-525K4-NL    525DS, 525KS, 525PS    Dutch

### DeVilbiss Concentrator 5 Liter Series Service Manual:

- LT-2023            525DS, 525KS, 525PS    English
- LT-2023-DE      525DS, 525KS, 525PS    German
- LT-2023-ES      525DS, 525KS, 525PS    Spanish
- LT-2023-FR      525DS, 525KS, 525PS    French
- LT-2023-PT      525DS, 525KS, 525PS    Portuguese

### DeVilbiss Oxygen Concentrator Service Log:

- A-1007            All                            English
- A-1007-PT        All                            Portuguese

### Orders may be placed by calling:

- Customer Service            800-338-1988
- Warranty parts - U.S.A.      800-338-1988
- International Department    814-443-4881
- Europe                        +49 (0) 621-178-98-0

## PARTS RETURN

Before returning parts or units to the factory, call the Drive DeVilbiss Healthcare Customer Service Department (800-338-1988) or (814-443-4881) to obtain a return authorization number. Include in the package a note indicating the return authorization number along with your company name, address, phone number, and account number. The return authorization number should also be written on the outside of the package.

To expedite your order for non-warranty parts, the following information should be given to the representative:

- Catalog number
- Serial number
- Hour meter reading for each concentrator
- Account number
- Company name and address
- Description of problem

## WARRANTY

Drive DeVilbiss Healthcare warrants the DeVilbiss 5 Liter Oxygen Concentrator under the conditions and limitations stated below. Drive DeVilbiss warrants this equipment to be free from defects in workmanship and materials for three (3) years from date of factory shipment to the original purchaser, (typically the healthcare provider) unless contractually specified otherwise. This warranty is limited to the Buyer of new equipment purchased directly from Drive DeVilbiss, or one of its Providers, Distributors, or Agents. Drive DeVilbiss' obligation under this warranty is limited to product repair (parts and labor) at its factory or at an Authorized Service Center. Routine maintenance items, such as filters, are not covered under this warranty, nor does it cover normal wear and tear.

### Warranty Claims Submissions

The original purchaser must submit any warranty claim to Drive DeVilbiss or to an Authorized Service Center. Upon verification of the warranty status, instructions will be issued. For all returns, the original purchaser must (1) properly package the unit in a Drive DeVilbiss approved shipping container, (2) properly identify the claim with the Return Authorization Number, and (3) send the shipment freight prepaid. Service under this warranty must be performed by Drive DeVilbiss and/or an Authorized Service Center.

**NOTE** – *This warranty does not obligate Drive DeVilbiss to provide a loaner unit during the time that an oxygen concentrator is undergoing repair.*

**NOTE** – *Replacement components are warranted for the unexpired portion of the original Limited Warranty.*

This warranty shall be voided, and Drive DeVilbiss shall be relieved of any obligation or liability if:

- The device has been misused, abused, tampered with, or used improperly during this period.
- Malfunction results from inadequate cleaning or failure to follow the instructions.
- The equipment is operated or maintained outside the parameters indicated in the DeVilbiss operating and service instructions.
- Unqualified service personnel conduct routine maintenance or servicing.
- Unauthorized parts or components (i.e., regenerated sieve material) are used to repair or alter the equipment.
- Unapproved filters are used with the unit.

THERE IS NO OTHER EXPRESS WARRANTY. IMPLIED WARRANTIES, INCLUDING THOSE OF MERCHANTABILITY AND FITNESS FOR A PARTICULAR PURPOSE, ARE LIMITED TO THE DURATION OF THE EXPRESS LIMITED WARRANTY AND TO THE EXTENT PERMITTED BY LAW ANY AND ALL IMPLIED WARRANTIES ARE EXCLUDED. THIS IS THE EXCLUSIVE REMEDY AND LIABILITY FOR CONSEQUENTIAL AND INCIDENTAL DAMAGES UNDER ANY AND ALL WARRANTIES ARE EXCLUDED TO THE EXTENT EXCLUSION IS PERMITTED BY LAW. SOME STATES DO NOT ALLOW LIMITATIONS ON HOW LONG AN IMPLIED WARRANTY LASTS, OR THE LIMITATION OR EXCLUSION OF CONSEQUENTIAL OR INCIDENTAL DAMAGES, SO THE ABOVE LIMITATION OR EXCLUSION MAY NOT APPLY TO YOU.

This warranty gives you specific legal rights, and you may also have other rights that vary from state to state.

**NOTE** – *International warranties may vary.*

# SPECIFICATIONS

## DEVILBISS 5-LITER SERIES

Catalog Number	525DS, 525DS-Q		525KS, 525KS-LT		525PS
<b>Delivery Rate</b> (Lower delivery rates available for low flow applications)	0.5 to 5 LPM		0.5 to 5 LPM		0.5 to 5 LPM
<b>Maximum Recommended Flow</b> (@ nominal outlet pressures of zero & 7 kPa)	5 LPM		5 LPM		5 LPM
<b>Outlet Pressure</b>	8.5 ± 0.5 psig (58.6 ± 3.5 kPa)		8.5 ± 0.5 psig (58.6 ± 3.5 kPa)		8.5 ± 0.5 psig (58.6 ± 3.5 kPa)
<b>Auxiliary Oxygen Port</b> ***	Outlet Pressure: <15 psi Outlet Flow: 2 LPM		Outlet Pressure: <15 psi Outlet Flow: 2 LPM		Outlet Pressure: <15 psi Outlet Flow: 2 LPM
<b>Electrical Rating</b>	115 V, 60 Hz, 3.3 Amp		220-230 V~, 50 Hz, 1.55 Amp 230 V~, 60 Hz, 1.9 Amp		220-230 V~, 60 Hz, 1.68 Amp
<b>Operating Voltage Range</b>	97-127 V~, 60 Hz		187-253 V~, 50 Hz 195-253 V~, 60 Hz		187-253 V~, 60 Hz
<b>Oxygen Percentage</b>	1-5 LPM=87%-96%		1-5 LPM=93%±3%		1-5 LPM=93%±3%
<b>Operating Altitude</b>					
(tested at 70°F {21°C} only) 0-1500 M (0-4921 ft)	Across the voltage range: No degradation of performance		Across the voltage range: No degradation of performance		Across the voltage range: No degradation of performance
1500-4000 M (4921-13123 ft)	Tested at nominal voltage only: No degradation of performance		Tested at 230V/50Hz only: No degradation of performance		Tested at 230V/60Hz only: No degradation of performance
<b>Operating Environment Range*</b>					
41°F (5°C) to 95°F (35°C), humidity range of 10% to 95%	No degradation in performance across the operating voltage range.		No degradation in performance across the operating voltage range.		No degradation in performance across the operating voltage range.
<b>Power Consumption</b>	310 Watts Average 275 Watts @ 1.2 LPM & below		230V / 50 Hz - 312 Watts Average 230V / 50 Hz - 296 Watts Average @ 1.2 LPM & below 230V / 60 Hz - 387 Watts Average 230V / 60 Hz - 369 Watts Average @ 1.2 LPM & below		230V / 60 Hz - 334 Watts Average 230V / 60 Hz - 297 Watts Average @ 1.2 LPM & below
<b>Weight</b>	36 lbs. (16.3 Kilograms)		36 lbs. (16.3 Kilograms)		36 lbs. (16.3 Kilograms)
<b>Safe Working Load</b>	53 lbs. (24 Kilograms)		53 lbs. (24 Kilograms)		53 lbs. (24 Kilograms)
<b>Sound Pressure Level at 3 and 5 LPM</b>	<b>525DS</b> 50.9 dBA @ 3 LPM 50.7 dBA @ 5 LPM	<b>525DS-Q</b> 46.7 dBA @ 3 LPM 46.7 dBA @ 5 LPM	<b>525KS</b> 47.9 dBA @ 3 LPM 47.9 dBA @ 5 LPM	<b>525KS-LT</b> 49.6 dBA @ 3 LPM 49.4 dBA @ 5 LPM	45.4 dBA @ 3 LPM 45.3 dBA @ 5 LPM
<b>Sound Power Level at 3 and 5 LPM</b>	<b>525DS</b> 54.7 dBA @ 3 LPM 54.5 dBA @ 5 LPM	<b>525DS-Q</b> 50.4 dBA @ 3 LPM 50.4 dBA @ 5 LPM	<b>525KS</b> 51.6 dBA @ 3 LPM 51.7 dBA @ 5 LPM	<b>525KS-LT</b> 53.4 dBA @ 3 LPM 53.2 dBA @ 5 LPM	49.2 dBA @ 3 LPM 49.1 dBA @ 5 LPM
<b>Sound Level (ISO 8359:1996)</b>	48 dBA (525DS) 46 dBA (525DS-Q)		40 dBA (50 Hz (525KS) 48 dBA (50 Hz (525KS-LT)		—
<b>Alarm Sound Level</b>	> = 62 dBA		> = 62 dBA		> = 62 dBA
<b>Dimensions</b>	24.5"H x 13.5"W x 12"D (62.2 x 34.2 x 30.4 cm)		24.5"H x 13.5"W x 12"D (62.2 x 34.2 x 30.4 cm)		24.5"H x 13.5"W x 12"D (62.2 x 34.2 x 30.4 cm)
<b>Pressure Relief Valve</b>	45 psig±5 psig (310 kPa±34.5 kPa)		45 psig±5 psig (310 kPa±34.5 kPa)		45 psig±5 psig (310 kPa±34.5 kPa)
<b>Maximum Limited Pressure</b>	Normal Condition: 9 PSIG (62.1 kPa), Single Fault Condition: 27.6 PSIG (190.3 kPa)		Normal Condition: 9 PSIG (62.1 kPa), Single Fault Condition: 27.6 PSIG (190.3 kPa)		Normal Condition: 9 PSIG (62.1 kPa), Single Fault Condition: 27.6 PSIG (190.3 kPa)
<b>Operating System</b>	Time Cycle / Pressure Swing		Time Cycle / Pressure Swing		Time Cycle / Pressure Swing
<b>Low Oxygen Indicator</b>	<82% low oxygen <60% very low oxygen		<82% low oxygen <60% very low oxygen		<82% low oxygen <60% very low oxygen
<b>Storage Conditions</b>	-13°F (-25°C) to 158°F (70°C), humidity range of 15% to 93% non-condensing		-13°F (-25°C) to 158°F (70°C), humidity range of 15% to 93% non-condensing		-13°F (-25°C) to 158°F (70°C), humidity range of 15% to 93% non-condensing
<b>Equipment Class and Type</b>	<input type="checkbox"/> Class II Equipment Double Insulated; ↑ Type B Applied Part, IP21		<input type="checkbox"/> Class II Equipment Double Insulated; ↑ Type B Applied Part, IP21		<input type="checkbox"/> Class II Equipment Double Insulated; ↑ Type B Applied Part, IP21

# SPECIFICATIONS

Catalog Number	525DS, 525DS-Q				525KS, 525KS-LT				525PS			
<b>Approval Body and Safety Standard</b>	TUV ANSI/AAMI ES60601-1:2005+A2 (R2012) +A1 IEC 60601-1-6:2010 IEC 60601-1-11:2015 ISO 80601-2-69:2014 **** CAN/CSA-C22.2 No. 60601-1:14 CAN/CSA-C22.2 No. 60601-1-6:11 CAN/CSA-C22.2 No. 60601-1-11:15 CAN/CSA-C22.2 No. 80601-2-69:16				TUV approved for 50 Hz only to IEC 60601-1:2012 IEC 60601-1-6:2010+A1 IEC 60601-1-11:2015 EN ISO 80601-2-69:2014				TUV IEC 60601-1:2012 IEC 60601-1-6:2010+A1 IEC 60601-1-11:2015 EN ISO 80601-2-69:2014			
<b>CE mark</b>	No				Yes				Yes			
<b>EMC Compliance To</b>	EN60601-1-2				EN60601-1-2				EN60601-1-2			
<b>Typical Accumulator Pressure at Maximum Recommended Flow**</b>												
	<b>Original System</b>		<b>Low Pressure System</b>		<b>Original System</b>		<b>Low Pressure System</b>		<b>Original System</b>		<b>Low Pressure System</b>	
<b>Altitude</b>	<b>PSI</b>	<b>kPa</b>	<b>PSI</b>	<b>kPa</b>	<b>PSI</b>	<b>kPa</b>	<b>PSI</b>	<b>kPa</b>	<b>PSI</b>	<b>kPa</b>	<b>PSI</b>	<b>kPa</b>
0 TO 457 M 0 TO 1500 FT.	23-32	159-221	18-27	124-186	23-32	159-221	18-27	124-186	23-32	159-221	18-27	124-186
457 TO 914 M 1500 TO 3000 FT.	21-29	145-200	16-25	110-172	21-29	145-200	16-25	110-172	21-29	145-200	16-25	110-172
914 TO 1524 M 3000 TO 5000 FT.	20-27	138-186	13-24	90-165	20-27	138-186	13-24	90-165	20-27	138-186	13-24	90-165

There will be a pressure swing during each cycle.

- 4 – 5 psi on original system
- 3 – 4 psi on low pressure system

\* **NOTE**– The OSD performance at 41°F (5°C) to 95°F (35°C), 93% R.H. through voltage range on the 525DS verified at 670m.

\*\* **NOTE**– The minimum and maximum pressures are peak accumulator pressures at 5 LPM.

\*\*\* **NOTE**– The maximum recommended flow is 3 LPM when an oxygen bottle is being filled with oxygen from the auxiliary oxygen port.

\*\*\*\* **NOTE**– Use of the 515LF-607 low output flow meter package or other low output flow meter accessory will prevent the device from meeting the requirements of ISO-80601-2-69:2014 Section 201.13.2.101.

Specifications subject to change without notice.

# ELECTROMAGNETIC COMPATIBILITY INFORMATION

## ELECTROMAGNETIC COMPATIBILITY INFORMATION



### WARNING

#### MR Unsafe

Do not bring the device or accessories into a Magnetic Resonance (MR) environment as it may cause unacceptable risk to the patient or damage to the oxygen concentrator or MR medical devices. The device and accessories have not been evaluated for safety in an MR environment.

Do not use the device or accessories in an environment with electromagnetic equipment such as CT scanners, Diathermy, RFID and electromagnetic security systems (metal detectors) as it may cause unacceptable risk to the patient or damage to the oxygen concentrator. Some electromagnetic sources may not be apparent, if you notice any unexplained changes in the performance of this device, if it is making unusual or harsh sounds, disconnect the power cord and discontinue use. Contact your home care provider.

This device is suitable for use in home and healthcare environments except for near active HF SURGICAL EQUIPMENT and the RF shielded room of an ME SYSTEM for magnetic resonance imaging, where the intensity of Electromagnetic DISTURBANCES is high.



### WARNING

Use of this equipment adjacent to or stacked with other equipment should be avoided because it could result in improper operation. If such use is necessary, this equipment and the other equipment should be observed to verify that they are operating normally.



### WARNING

Portable RF communications equipment (including peripherals such as antenna cables and external antennas) should be used no closer than 30 cm (12 inches) to any part of the oxygen concentrator, including cables specified by the manufacturer. Otherwise, degradation of the performance of this equipment could result.

## Electromagnetic Compatibility

TEST DESCRIPTION	SPECIFICATION	NOTES	RESULTS
<b>CISPR11 &amp; IEC 60601-1-2:2014 (4TH EDITION)</b>			
Conducted Emissions	EN 55011:2009	Class B 150kHz – 30MHz	Complies
Radiated Emissions	EN 55011:2009	Class B 150kHz – 30MHz	Complies
Harmonic Current Emissions	EN 61000-3-2:2014	AC Input ≤16Amps	Complies
Voltage Fluctuations & Flicker	EN 61000-3-3:2013	AC Input ≤16Amps	Complies
Electrostatic Discharge Immunity	EN 61000-4-2:2008	±2kV, ±4kV, ±8kV, ±15kV (Air) 8kV (Contact)	Complies
Radiated Electromagnetic Field Immunity	EN 61000-4-3:2006	80MHz to 2.7GHz @ 10V/m; 80% AM at 1kHz	Complies
Fast Transient/Burst Immunity	EN 61000-4-4:2004	±2kV for Power Lines & ±1kV for I/O Lines	Complies
Surge Immunity	EN 61000-4-5:2006	±0.5kV & ±1kV (L-N) @ 0, 90 and 270°	Complies
Conducted RF Immunity	EN 61000-4-6:2009	150kHz to 80MHz @ 3Vrms 6V in ISM and Amateur Radio bands between 150kHz-80MHz 80% AM at 1kHz	Complies
Magnetic Field Immunity	EN 61000-4-8:2010	30A/m @ 50Hz & 60Hz	Complies
Voltage Dips, Short Interruptions & Variations	EN 61000-4-11:2004	>95%/0.5 cycle 60%/5 cycles 30%/25 cycles >95%/5 seconds	Complies





**DeVilbiss Healthcare LLC**  
100 DeVilbiss Drive  
Somerset, PA 15501-2125  
USA  
800-338-1988 • 814-443-4881

**Drive DeVilbiss Healthcare Ltd.**  
Heathfield Lane  
Birkenshaw  
West Yorkshire BD11 2HW  
ENGLAND  
+44 (0) 845 0600 333

**Australian Sponsor:**  
**Drive DeVilbiss Australia Pty Limited**  
Building F, 2 Hudson Ave  
Castle Hill, NSW 2154  
AUSTRALIA  
+61 02 9899 3144

**Drive DeVilbiss Healthcare France**  
Chaussée du Ban la Dame  
Parc d'activités Eiffel Energie  
ZAC du Ban la Dame - BP 19  
54390 Frouard  
FRANCE  
+33 (0) 3 83 495 495



**DeVilbiss Healthcare GmbH**  
Kamenzer Straße 3  
68309 Mannheim  
Germany  
+49 (0) 621-178-98-0

DeVilbiss Healthcare LLC • 100 DeVilbiss Drive • Somerset, PA 15501 • USA  
800-338-1988 • 814-443-4881 • [www.DeVilbissHealthcare.com](http://www.DeVilbissHealthcare.com)

DeVilbiss® and OSD® are registered trademarks of DeVilbiss Healthcare. Teflon® is a registered trademark of DuPont. Snoop® is a registered trademark of SWAGELOK

© 2021 DeVilbiss Healthcare LLC. 02.21 All Rights Reserved.

LT-2023 Rev. N